

INST.No.INE-807

**CHINO**

---

**Digital Program Controller**

**KP1000**

**[General]**

---

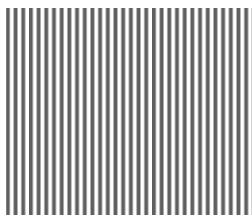
 **INSTRUCTIONS**

**CHINO**



## Table of Contents

<b>1. Introduction</b> .....	<b>- 1 -</b>	<b>9. Operation</b> .....	<b>- 56 -</b>
<b>2. For safe use of the product</b> .....	<b>- 3 -</b>	9-1. Confirmations before operation .....	- 56 -
2-1. Prerequisites for use .....	- 3 -	9-2. Program operation and run operation .....	- 56 -
2-2. Symbol mark.....	- 3 -	9-3. Trial operation .....	- 59 -
2-3. Important .....	- 4 -	9-4 Constant value operation.....	- 60 -
<b>3. Model code list</b> .....	<b>- 5 -</b>	9-5. Automatic output operation and manual output operation. -	61 -
<b>4. Mounting and wiring</b> .....	<b>- 6 -</b>	9-6. Precautions during operation .....	- 62 -
4-1. External dimensions .....	- 6 -	<b>10. Detailed explanation of main functions</b> -	<b>64 -</b>
4-2. Mounting.....	- 7 -	10-1 Measurement range.....	- 64 -
4-3. Wiring .....	- 9 -	10-2 .Linear scale .....	- 65 -
<b>5. Name of various parts</b> .....	<b>- 20 -</b>	10-3. Alarm mode .....	- 66 -
5-1.Entire overview.....	- 20 -	10-4. Auto tuning .....	- 68 -
5-2. Overview of the front panel.....	- 20 -	10-5. PID control .....	- 69 -
5-3 Front Details .....	- 21 -	10-6 Automatic PID switching system.....	- 70 -
<b>6. Operation screen</b> .....	<b>- 23 -</b>	10-7. Actuator adjustment of ON-OFF servo type... -	71 -
6-1. Output display screen.....	- 23 -	10-8. Output 2.....	- 72 -
6-2 Time display screen .....	- 24 -	10-9. Transmission signal output .....	- 73 -
6-3 Program pattern overall display screen.....	- 24 -	10-10. External signal input.....	- 74 -
6-4. Output display screen of output 2 specifications. -	25 -	10-11. External signal output .....	- 76 -
6-5. Operation screen and setting screen .....	- 26 -	10-12. Master slave synchronous operation .....	- 77 -
<b>7. Setting screen</b> .....	<b>- 27 -</b>	10-13. Communications interface.....	- 79 -
7-1. Basics of setting .....	- 27 -	<b>11. Engineering port</b> .....	<b>- 80 -</b>
7-2. Mode 0 [Settings of parameters that are being executed] -	29 -	<b>12.Trouble shooting</b> .....	<b>- 81 -</b>
7-3. Mode 1 [Settings related to operation status] -	31 -	<b>13. Checking and maintenance</b> .....	<b>- 83 -</b>
7-4. Mode 2 [Settings related to program pattern]... -	33 -	13-1. Checking .....	- 83 -
7-5. Mode 3 [Settings related to PID and alarm].....	- 37 -	13-2. Life component.....	- 83 -
7-6. Mode 4 [Settings related to output].....	- 40 -	13-3. Disposal.....	- 83 -
7-7. Mode 5 [Settings related to input] .....	- 43 -	<b>14. Explanation of terms</b> .....	<b>- 84 -</b>
7-8. Mode 6 [Settings related to time event].....	- 46 -	<b>15. Accessories</b> .....	<b>- 88 -</b>
7-9. Mode 7 [Settings related to transmission output] -	47 -	15-1. Front protective cover .....	- 88 -
7-10. Mode 8 [Settings related to communications]-	48 -	15-2. Contact protection element.....	- 88 -
7-11. Mode 11 [Settings related system] .....	- 49 -	<b>16. Specifications</b> .....	<b>- 89 -</b>
7-12. Initializing the setup parameter .....	- 50 -	<b>17. Parameter list</b> .....	<b>- 93 -</b>
7-13. Precautions while setting.....	- 51 -	<b>18. Parameter directory list</b> .....	<b>- 99 -</b>
7-14. Error message.....	- 52 -	<b>19. Engineering unit sticker</b> .....	<b>- 101 -</b>
<b>8. Initial settings</b> .....	<b>- 55 -</b>		

---

---

# 1. Introduction

---

---

Thank you for purchasing Digital Program Controller 'KP 1000 series'.

KP 1000 series is Digital Program Controller with indicating accuracy of  $\pm 0.1\%$ , control cycle of approximately 0.1 seconds and front size of 96X96mm.

Various functionalities like universal input and storing maximum 19 types of program patterns are provided as standard provisions. Besides a digital indicator with large easy to view LED display, various settings have an interactive system due to high resolution dotmatrix LCD display and handling is also easy with precise control.

Understand this controller properly and read this instruction manual beforehand in order to avoid any trouble.

This is a 'General' instruction manual. For specifications regarding communications, read 'Communication' instruction manual in addition to with this manual.

## Request

### — For the persons doing instrumentation, installation and sales —

Be sure to handover this instruction manual to the persons using this product.

### — For the users of this product —

Preserve this instruction manual until you scrap this product.  
Write down and keep the contents of setting.

## Notice

1. You should not copy or forward fully or partially this document without prior notice.
2. The contents of this document may be changed without notice.
3. We have taken enough care regarding the contents of this document however if at all you notice a mistake, contact our nearest office.
4. Please understand that regarding the result of the operation, whatever is the result the company will not be responsible.

## ■ Before use

After opening the pack, confirm the following before using the product. Although it is rare but if you notice anything wrong, contact your dealer or our nearest office.

### 1. Confirm the exterior

Confirm that the product is not broken on the outer side.

### 2. Confirm the model code

Confirm that the model code is that of the model that you purchase.

#### ◆ Model code label and its location

A label as shown below is pasted on the upper surface of the controller unit.

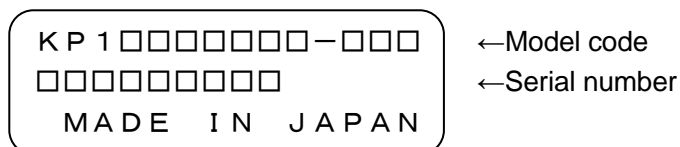

### 3. Confirm the accessories

The following accessories are attached to the controller, confirm them.

Name	Quantity	Remarks
Mounting bracket	2 (1 set)	For panel mounting
Contact protection element	1	Attached to ON-OFF servo type specifications only
Instruction manual (General)	1	This document
Instruction manual (Communications interface)	1	Attached to communications specifications only (in CD-R)

When accessories are requested separately, sometimes those are also attached.

## Attention

1. Do not drop the instrument while taking it out of the box.
2. When transporting this instrument, pack the instrument in the box and then put it with cushions in another box. We recommend keeping the box for transport.
3. When not using the instrument for a while after taking it from the panel, put the instrument in the box and store at room temperature and in a dust free atmosphere.

---

---

## 2. For safe use of the product

---

---

In order to use this product safely, read the following precautions and understand them.

### 2-1. Prerequisites for use



This product is a general product of component type that is to be used by mounting it in a panel for instrumentation inside a room. Do not use it in any other condition.

When using, design a fail safe on the final product side and review regularly and use the controller after confirming the safety of the system. For the wiring, adjustment and operation of this product contact a professional having knowledge of instrumentation.

It is necessary that the people actually using this controller read this instruction manual, and have enough understanding of various precautions and the basic operations of this product.

### 2-2. Symbol mark

The following symbol marks are used in the product itself and in this instruction manual hence understand the meaning of these symbol marks properly.

Symbol mark	Meaning
 <b>Warning</b>	If there is a possibility of death or severe injuries then explain the precautions to avoid that possibility.
 <b>Precaution</b>	If there is a possibility of small injuries or a possibility of this product or its nearby devices getting damaged then explain the precautions to avoid those possibilities.
	It is a symbol for ground terminal. Always connect the ground terminal to protective grounding.

### **Warning**

#### **Perchlorate Material**

This instrument uses battery with Perchlorate Material.

Special handling may apply, see

<http://www.dtsc.ca.gov/hazardouswaste/perchlorate>

## 2-3. Important



### Warning

In order to avoid severe accidents always read these contents and understand them.

#### 1. Confirm the power supply voltage and wiring

Before supplying the power to the instrument, check that the wiring is correct, power supply voltage matches with the rated voltage and grounding is done.

#### 2. Install over current protection device

This product does not have a power supply switch. In the power supply of this product, install an over current protection device (Breaker etc.) that matches the rating specifications.

#### 3. Protection of terminal

To prevent electric shock, provide the terminal of this product with safety measures such that the user will not directly be able to touch the final product.

#### 4. Installing the safety device

Regarding the use of a device that anticipates a big loss due to failure of this product and the peripheral devices, always install a safety device for preventing these losses and implement fail safe design in the final product. Do not use it in important utilities facilities in which human life, atomic energy, aviation, space etc, are involved.

#### 5. Do not put your hands inside this product

Do not put your hand and tool inside this product. You may get an injury or an electric shock.

#### 6. Power cut off in case of suspicion

If there is an offensive smell, a strange noise or smoke or if the temperature increases abnormally, it is very risky hence cut off the power supply immediately and contact the dealer or our nearest office.

#### 7. Prohibiting repairing and remodeling

If repairing or remodeling is necessary, contact the dealer or our nearest office. Only the service engineers appointed by our company will change the parts, do the repairing and remodeling.

#### 8. Strictly follow the instruction manual

In order to use this product correctly and safely, follow this instruction manual. Please understand beforehand that our company will not at all be responsible for any claims for injury, damage and passive damage due to wrong use of the product.

# 3. Model code list

K P 1 ④ ⑤ ⑥ C ⑧ ⑨ ⑩ – ⑫ ⑬ ⑭

## ④ Input signal

- 0: Universal input
- 4: 4-wire resistance thermometer

## ⑤ Control mode (Output number 1)

- 1: ON-OFF pulse type PID
- 2: ON-OFF servo type PID (Standard specification)
- 3: Current output type PID
- 5: SSR drive pulse type PID
- 6: Voltage output type PID
- 8: ON-OFF servo type PID (Very little load specifications)

## ⑥ Control mode (Output number 2)\*

- 0: None
- 1: ON OFF pulse type PID method \*1
- 3: Current output type PID method \*1
- 5: SSR drive pulse type PID metho \*1
- 6: Voltage output type PID method \*1

## ⑧ Communication interface\*

- 0: None
- R: R S 2 3 2 C
- A: R S 4 2 2 A
- S: R S 4 8 5
- T: 5 time signal output
- N: 4 status signal outputs + End signal
- D: 4 external drive inputs
- P: Pattern select input
- M: 4 time signal output + End signal

## ⑨ Transmission signal output\*

- 0: None
- 1: 4-20mA
- 2: 0-1V
- 3: 0-10V
- 4: Other
- T: 5 time signal outputs
- N: 4 status signal outputs + End signal
- D: 4 external drive inputs
- P: Pattern select input
- M: 4 time signal output + End signal

## ⑩ External drive input\*

- 0: None
- 5: 4 time signal outputs + end signal + 3 external drive inputs
- 6: 5 time signal outputs + 3 external drive inputs
- 7: 4 status signal outputs + 4 external drive inputs
- 8: 3 external drive inputs + Pattern select input
- T: 5 time signal outputs
- N: 4 status signal outputs + End signal
- D: 4 external drive inputs
- P: Pattern select input
- M: 4 time signal outputs + End signal

## ⑫ Case color

- G: Gray
- B: Black

## ⑬ IP54 panel sealing specifications and terminal cover\*

- 0: None
- 1: Terminal cover
- 2: IP54 panel sealing specifications + No terminal cover exists
- 3: IP54 panel sealing specifications + Terminal cover

## ⑭ Power supply voltage

- A: 100-240V (AC)
- D: 24V (AC/DC)

### \*Option

\*1: Control mode (output number 1) can be selected from 1, 3, 5, 6.

Note: Common options of zone 1,2,3 are designated priority form zone 3 ordering [T], [N], [D], [P], [M]



## 4. Mounting and wiring

### 4-1. External dimensions

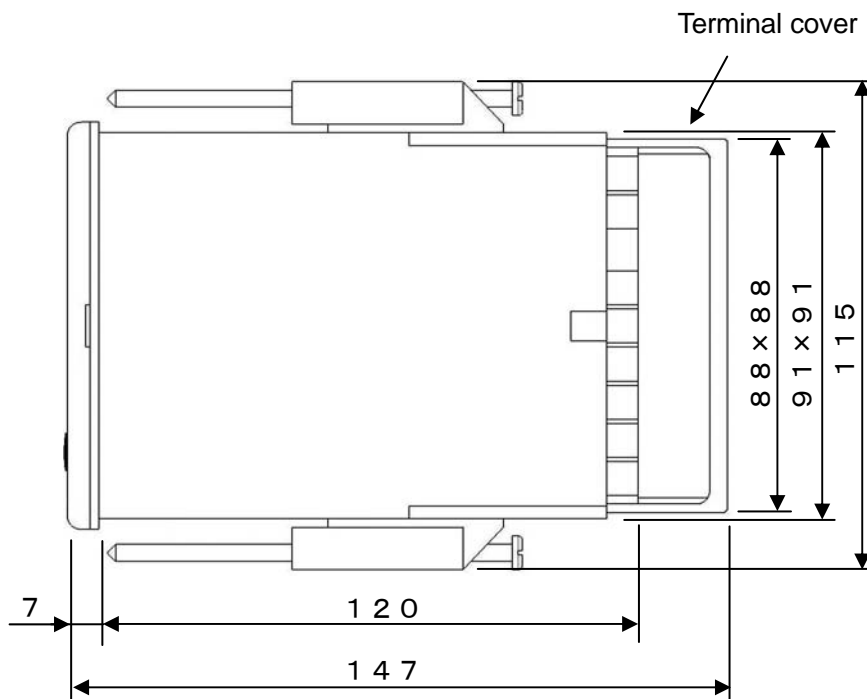
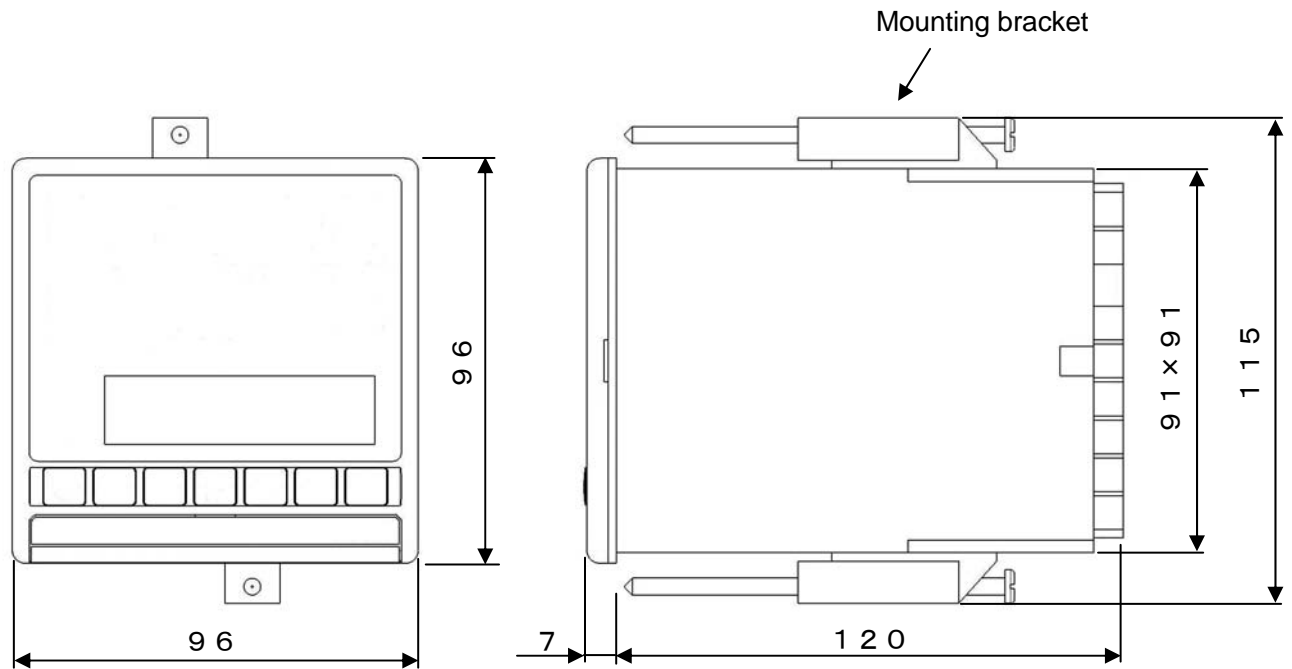

Unit: mm

## 4-2. Mounting

### 4-2-1. Panel cutout and mounting method

#### 1. Usual mounting method

- ① Insert this product in panel cutout.
- ② Fit in the attached mounting bracket above and below and tighten the screws with the driver and fix it.  
When the screws are tightened the torque is '0.6 – 0.8 Nm'.
- ③ For IP54 panel sealing specifications, confirm that the gasket between product and panels is correct.  
Take care because if the gasket drifts or if there is a gap, the mounting is not proper and the water proofing function does not work.

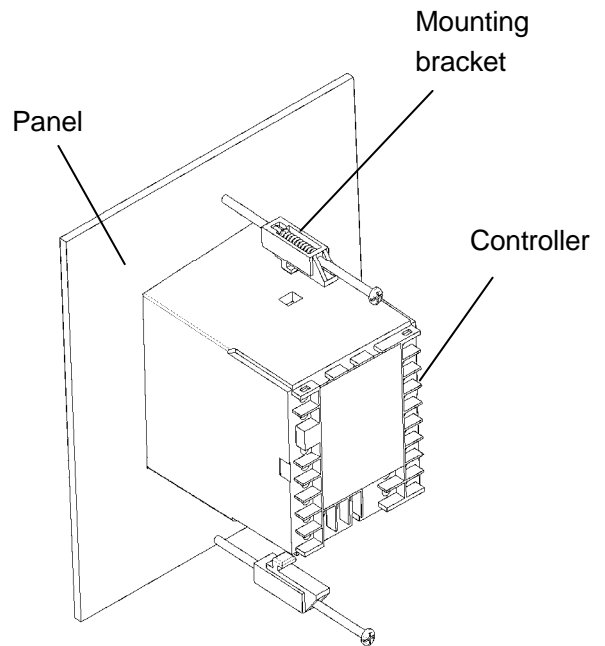
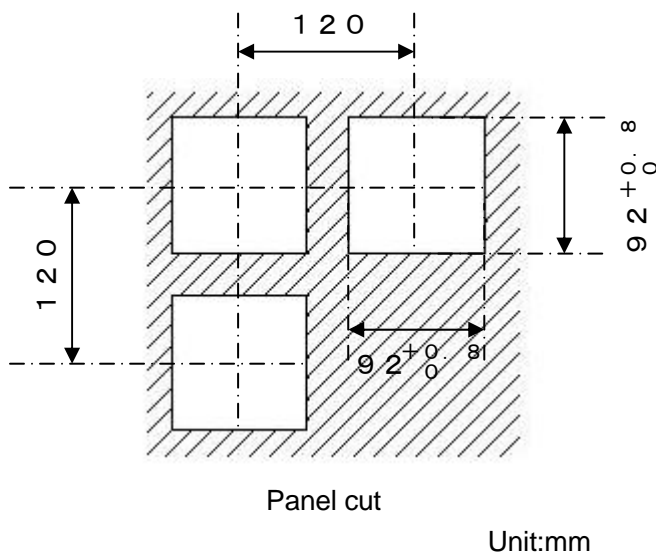

#### 2. Closed instrumentation

- ① Insert this product in panel cutout.
- ② Fit in the attached mounting bracket above and below and tighten the screws with the driver and fix it.  
When the screws are tightened the torque is '0.6 - 0.8 Nm'.
- ③ At the time of closed instrumentation, even in the product of IP54 panel sealing specifications, as the gasket functionality between the product and the panel is lost, water proofing functionality does not work.

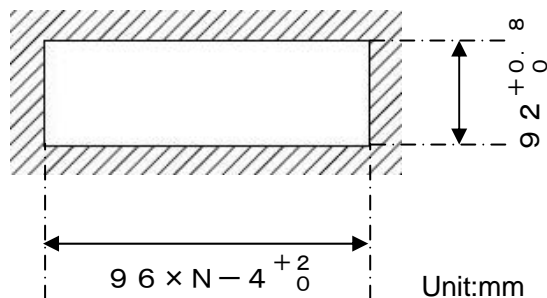

N: Number of mounted instruments

Panel cutout for closed instrumentation

## 4-2-2. Installation condition



### Precaution

In order to avoid accidents always read and understand these contents.

#### 1. Environment

- ① In a room.
- ② Away from direct sunlight.
- ③ Away from high temperatures.
- ④ Where there are no vibrations and shocks.
- ⑤ Away from liquids (water etc.).
- ⑥ Away from condensation.
- ⑦ Under 'Excess voltage category II , Pollution level 2' based on EN standards.

#### 2. Atmosphere

- ① Away from strong noise, static electricity, electric field, magnetic field etc.
- ② Surrounding temperature within -10 to 50°C (Less than 40°C in case of closed instrumentation), surrounding humidity within 10-90% RH.
- ③ Variation in temperature is less.
- ④ Away from corrosive gas, explosive gas, ignition gas and combustible gas.
- ⑤ Away from salt, iron and conductive material (Carbon, iron etc.).
- ⑥ Away from steam, oil and chemicals etc.
- ⑦ Away from dust etc.
- ⑧ Away from the surroundings where high temperature is generated.
- ⑨ Away from places where temperature remains stored.
- ⑩ Upper part of the product that has a large space.
- ⑪ Away from wind.

#### 3. Mounting position

- ① Installation height is less than 2,000 m above the sea level.
- ② Mounting position is approximately 1.5m (Approximately eye level position of a person).
- ③ Mounting orientation longitudinal tilting is less than  $\pm 10^\circ$  lateral tilting is less than  $\pm 10^\circ$ .

#### 4. Other

- ① Do not wipe this product with an organic solvent (like alcohol).
- ② To avoid malfunctioning of this product, do not use cell phones in its vicinity.
- ③ An obstacle may be created for television and radio sets placed near this product.

## 4-3. Wiring

### 4-3-1. Terminal number and functionality

Depending on the product specifications, there are also places where terminal screw is not provided.

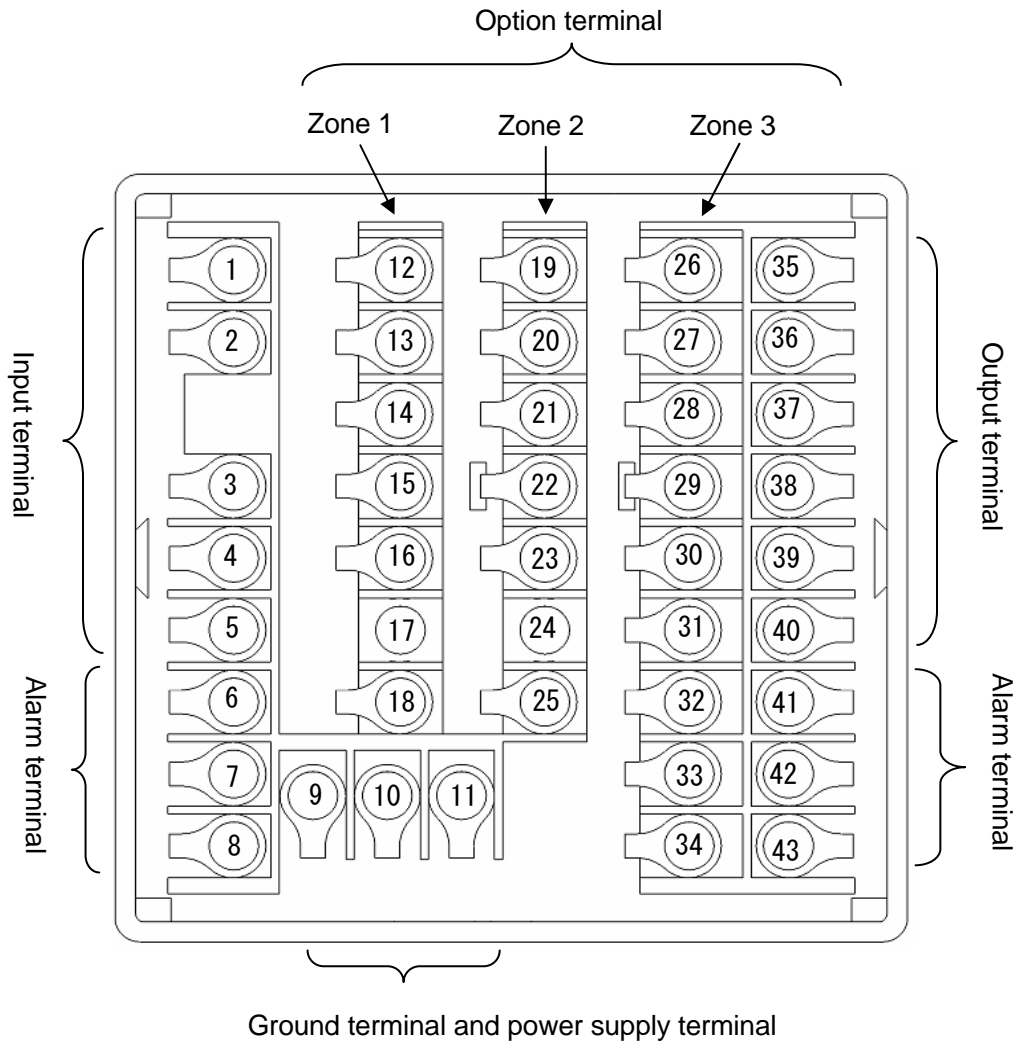

#### 1. Power supply terminal

##### ① General power supply specifications

Terminal number	
⑨	⊥
⑩	N
⑪	L

100-240VAC  
(50/60Hz)

##### ② 24V power supply specification

Terminal number	For 24 V DC	For 24 V AC
⑨	⊥	⊥
⑩	-	N
⑪	+	L

24VDC      24VAC (50/60Hz)

## 2. Input terminal

Terminal number	Thermocouple Voltage mV	Voltage mV (Range No.35) (Range No.37)	Current mA (Range No.36)	Resistance thermometer (3 wire)	Resistance thermometer (4 wire)
①		⊕	⊕		Ⓐ
②	⊕			Ⓐ	Ⓐ
③	⊖	⊖	⊖	Ⓑ	Ⓑ
④				Ⓑ	Ⓑ
⑤			⊖		

Note) Do the wiring only for the specified terminals.

Note) For current mA, short circuit ③ and ⑤.

## 3. Output terminal

### ① ON-OFF pulse type

Terminal number	Internal circuit
Output 1	③⑤ N.C.
	③⑥ COM.
	③⑦ N.O.
Output 2	③⑧ N.C.
	③⑨ COM.
	③⑩ N.O.

### ② ON-OFF servo type

Terminal number	Internal circuit
③⑤	CLOSE
③⑥	OPEN
③⑦	COM.
③⑧	OPEN
③⑨	COM.
③⑩	CLOSE

③ Current output type, SSR drive pulse type, Voltage output type

Terminal number	Current output type	SSR drive pulse type	Voltage output type
Output 1	③⑤	+	+
	③⑥	-	-
	③⑦		
Output 2	③⑧	+	+
	③⑨	-	-
	④⑩		

4. Alarm terminal

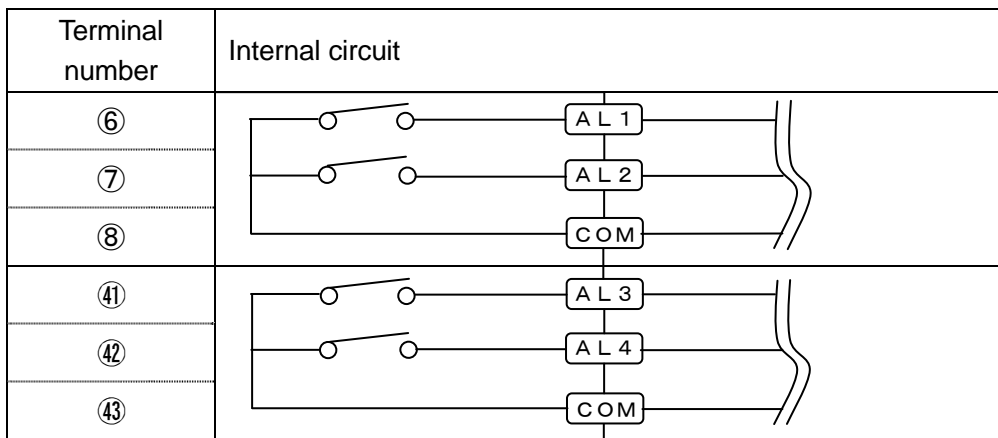

Note) Common (COM) terminal is common in AL1/AL2 and Common (COM) terminal is common in AL3/AL4.

5. Option terminal

① Zone 1

Terminal number	Communication RS232C	Communication RS422A	Communication RS485
⑫	RD	RDA	SA
⑬	SD	RDB	SB
⑭	SG	SDA	SG
⑮		SDB	
⑯		SG	
⑰			
⑱			

Terminal number	Time signal 5 points	Status signal 4 points + End signal	External drive input 4 points	Select pattern input	Time signal 4 points + End signal
⑫	TS1	RUN/STOP		PTN10	TS1
⑬	TS2	ADV	WAIT	PTN 8	TS2
⑭	TS3	RESET	RESET	PTN 4	TS3
⑮	TS4	WAIT	ADV	PTN 2	TS4
⑯	TS5	END	RUN/STOP	PTN 1	END
⑰					
⑱	COM	COM	COM	COM	COM

② Zone 2

Terminal number	Transmission signal output	Time signal 5 points	Status signal 4 points + End signal	External drive input 4 points	Select pattern input	Time signal 4 points + End signal
⑲		TS1	RUN/STOP		PTN10	TS1
⑳		TS2	ADV	WAIT	PTN 8	TS2
㉑	⊕	TS3	RESET	RESET	PTN 4	TS3
㉒	⊖	TS4	WAIT	ADV	PTN 2	TS4
㉓		TS5	END	RUN/STOP	PTN 1	END
㉔						
㉕		COM	COM	COM	COM	COM

③ Zone 3

Terminal number	Time signal 4 points + End signal + External drive input 3 points	Time signal 5 points + External drive input 3 points	Status signal 4 points + External drive input 4 points	Select pattern input + External drive input 3 points
⑳	TS1	TS1	RUN/STOP	PTN10
㉑	TS2	TS2	ADV	PTN 8
㉒	TS3	TS3	RESET	PTN 4
㉓	TS4	TS4	WAIT	PTN 2
㉔	END	TS5	WAIT	PTN 1
㉕	RESET	RESET	RESET	RESET
㉖	ADV	ADV	ADV	ADV
㉗	RUN/STOP	RUN/STOP	RUN/STOP	RUN/STOP
㉘	COM	COM	COM	COM

Terminal number	Time signal 5 points	Status signal 4 points + End signal	External drive input 4 points	Select pattern input	Time signal 4 points + End signal
②6	TS1	RUN/STOP		PTN10	TS1
②7	TS2	ADV	WAIT	PTN 8	TS2
②8	TS3	RESET	RESET	PTN 4	TS3
②9	TS4	WAIT	ADV	PTN 2	TS4
③0	TS5	END	RUN/STOP	PTN 1	END
③1					
③2	COM	COM	COM	COM	COM
③3					
③4					



## 4-3-2. Basics of wiring



### Precaution

In order to avoid accidents always read and understand these contents.

#### 1. Connecting to the terminal

- ① For wiring of terminal use crimp style terminal with insulating sleeve. Always use O type terminal to secure safety of power supply terminal and grounding terminal. For other types of terminals also we recommend that you use O type terminal.

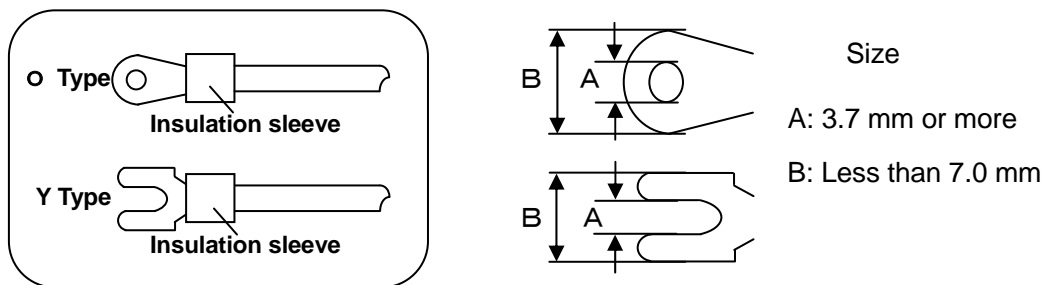

- ② Tightening torque of terminal screw is '0.6 - 0.8Nm'. If a torque exceeding this value is applied, terminal screw section will be damaged, hence take care.

#### 2. Power supply terminal

- ① In power supply, place the over current protection device and switch that conforms to the ratings of the controller within 3m so that they are easily reachable.

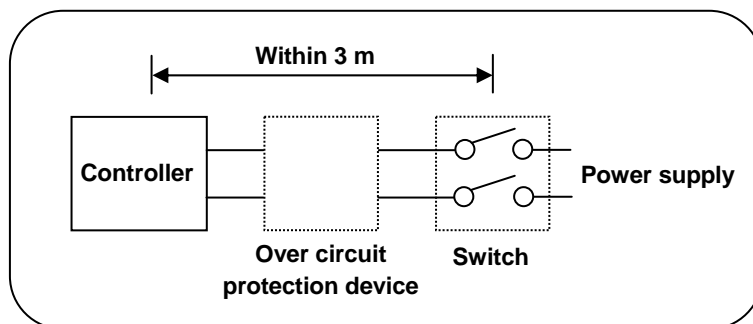

- ② Use a power supply with 600V vinyl insulation electric line (rating more than 1A AC) and an equal or greater electric wire.
- ③ To avoid malfunctioning use good quality single phase power supply with little voltage change, wave form distortion and noise. If the noise is loud use noise filter and insert insulation transformer etc.
- ④ There is a little leakage of current flow in case or rated power supply hence take care. Leaking current is approximately 1mA.



### Warning

To avoid serious accidents always cut off the power supply and then do then wiring.

### 3. Input terminal

- ① Maximum permitted input of input terminal is as follows. Take care of not applying the input that exceeds these values. If an input that exceeds the range is applied, the product may get out of order or its performance may deteriorate remarkably or it may malfunction.
  - Thermocouple, voltage mV, voltage V : Less than  $\pm 20V$
  - Resistance thermometer : Less than  $500\Omega$  or Less than  $\pm 5V$ .
  - Current mA : Less than  $\pm 30mA$  or Less than  $\pm 7.5 m$ .
- ② Parallel connection of input is not allowed. Not only measurement error occurs, but also stable control is not performed and an error occurs in the entire system.
- ③ For thermocouple, do the wiring up to the input terminal of the product by a thermocouple or compensation lead wire.
- ④ To avoid measurement error for resistance thermometer, use cable such that resistance value of each wire is equal. Take care as burn out is not provided for 4-wire resistance thermometer.
- ⑤ When connecting a protection device like zenner barrier for input protection, sometimes a big measurement error may occur. Confirm the combination with protection device and maintain the allowable signal source resistance and allowable wire resistance of the controller.

### 4. Output terminal

- ① Use an output terminal within the rating range. If a load that is out of range is connected, product may get out of order, its performance may show a remarkable deterioration or it may malfunction.
- ② For relay output terminal of ON-OFF pulse type and ON-OFF servo type connect the load through buffer relay. For contact protection of product internal relay and for noise reduction always insert a contact protection device on the coil side of the buffer relay. In the controller also, a small type of contact protection device is built-in for internal relay protection. Take care because a small leak current flows through this contact protection device and load voltage.  
Leak current is approximately 2mA when load voltage is 200V AC and it is approximately 1mA when load voltage is 100V AC.

### 5. Alarm terminal

- ① Use the alarm terminal within the rating range. If a load that is out of range is applied, product may get out of order, its performance may show a remarkable deterioration or it may malfunction.
- ② For alarm terminal always connect the load through buffer relay. For contact protection of product internal relay and for noise reduction always insert a contact protection device on the coil side of the buffer relay.

### 6. Option terminal

- ① Use the option terminal within the rating range. If a load that is out of range is applied, product may get out of order, its performance may show a remarkable deterioration or it may malfunction.

 <b>Precaution</b>	<ol style="list-style-type: none"><li>① If a power supply that is out of range is connected, product may get out of order, its performance may show a remarkable deterioration or it may malfunction.</li><li>② If an excess current or excess voltage is applied to input output of the controller, it may get out of order, its performance may show a remarkable deterioration or it may malfunction.</li></ol>
---	--

### 4-3-3. Example of wiring

#### 1. ON-OFF servo type wiring

ON-OFF servo type is connected with a motor. Refer to the terminal diagram of the motor that uses three terminals of control relay output and three terminals of feedback input and do the wiring.

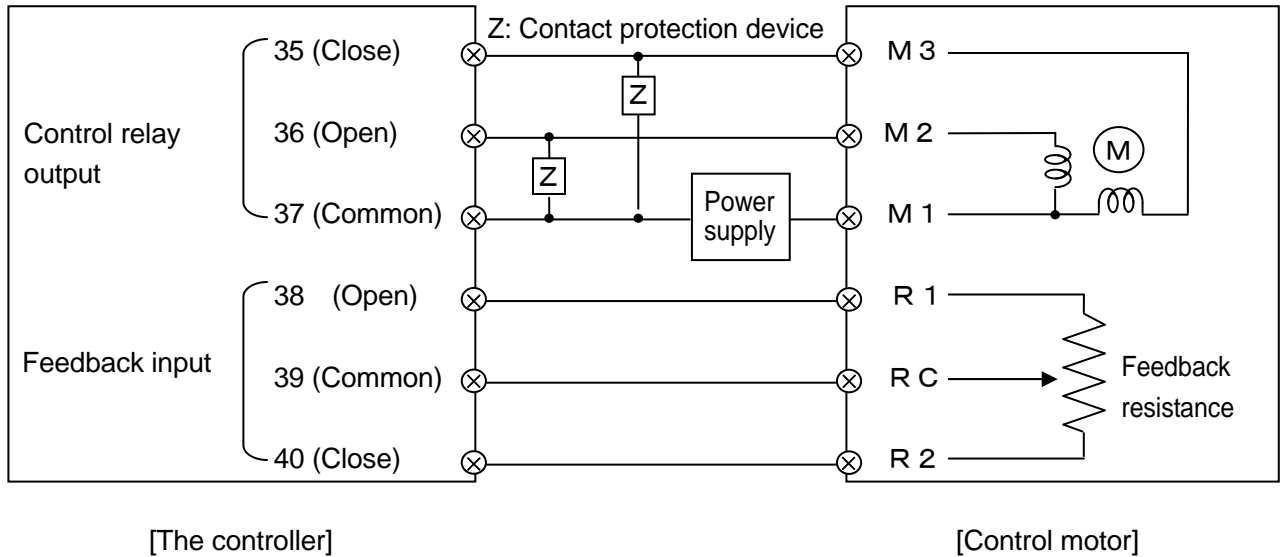

In the above diagram, the controller and control motor manufactured by our company are directly connected however, while actually connecting always insert a buffer relay and then connect. Furthermore, always connect a contact protection device in control relay output terminal.

The contact protection device attached to the controller is for the motor (For load current 700 mA and above). When connecting with buffer relay, use a contact protection device for light load. If contact protection device of the attachment is used in buffer relay, operation defect occurs due to leak current.

For your reference symbolic name list of motors of various companies is given below.

Symbolic name list of motors of various companies				
Chino Products	Toho Products	Shin Nippon Keisetsu Products	Japan Servo Products	Yamatake Products
M3	S	S	T2	1
M2	O	O	T1	2
M1	C	C	T3	3
R1	BM	B	B	Y
RC	RM	R	R	T
R2	WM	W	W	G

## 2. Relay output wiring example

In relay outputs like ON-OFF pulse type, ON-OFF servo type and alarm output, always load and connect through buffer relay and contact protection device.

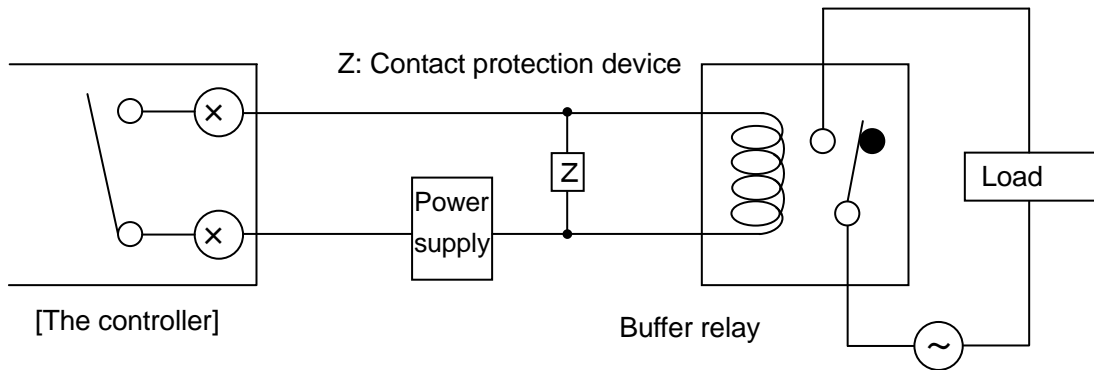

Contact protection device is handled in our company also (See 15. Accessories).

When power supply is an alternating power supply, and when CR compound device and power supply are direct current type, diode is generally used.

## 3. Wiring example of external signal input

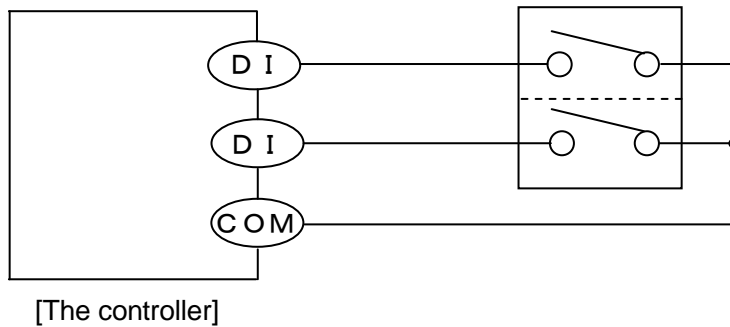

In the figure on the left approximately 5V and 2mA is applied. Take care about the contact capacity.

Pattern number selection from external signal input and program operation from external drive input can be done by short circuiting the specified external drive input terminal and common (COM) terminal. Generally the operation is done by using switch or relay however, it can also be done by open collector signal of peripheral equipments.

## 4. Wiring example of external signal output

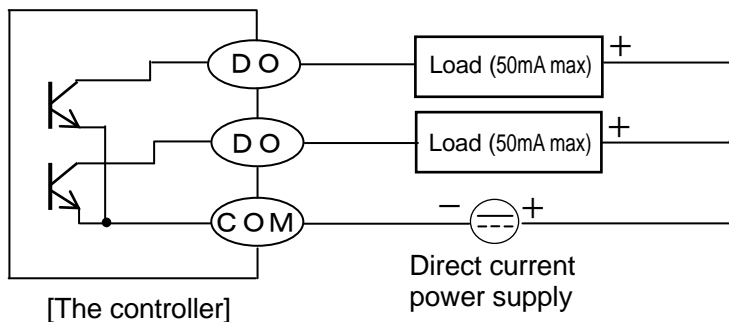

Rated scope of open collector signal is direct current load, maximum voltage 24VDC, maximum current less than 50mA. Take care about the load capacity.

Various external signal outputs (Time signal and status signal) are output using open collector signal. If power supply other than alternate power supply and load other than the rated scope is applied, the controller may become out of order or its performance may deteriorate or it may malfunction.

In open collector signal, if the load capacity is small, refer to the following and connect to the load through buffer relay. In order to reduce noise, insert contact protection device on the coil side of buffer relay.

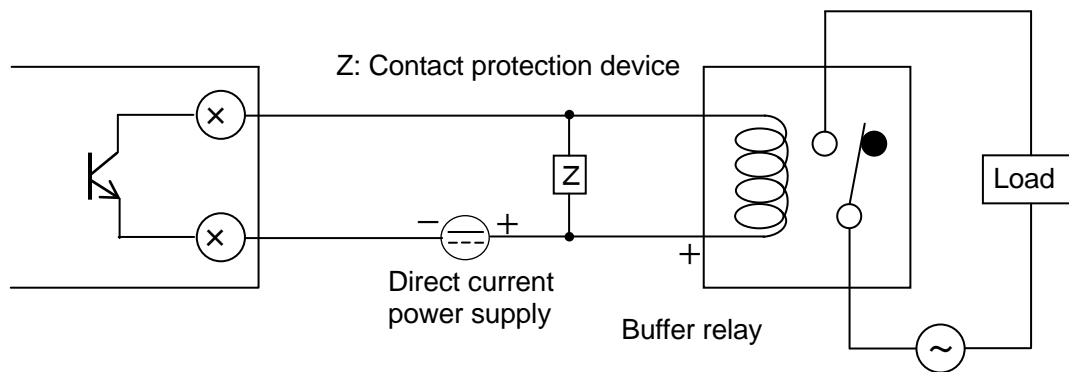

#### 4-3-4. Precautions while wiring



In order to avoid accidents always read and understand these contents.

##### **1. Wiring is done by professional**

Wiring is to be done by a person having actual experience and basic knowledge of instrumentation.

##### **2. Put the terminal cover**

In order to ensure safety, after the wiring is done, take measures so as to prevent direct contact with the terminal of the product.

Exclusive terminal cover of the controller is available as accessory (Sold separately).

##### **3. Keep away from strong electric circuit and from noise source**

In order to prevent bad effect due to noise, do not place the controller near a device from which noise is generated (magnet relay, motor, thyristor regulator, inverter etc.). Also avoid passing the wiring of the controller and that of noise generating devices through the same duct. Always keep the wiring away from each other. Take the necessary countermeasures against noise.

##### **4. Careful about connecting ground terminal**

Good grounding is important for reliability of the instrument. In most cases, it is better that each instrument is connected at a point. When connected separately, it is easy to get a bad effect due to noise. Check the connecting route.

##### **5. Keep away from heat generating sources**

In order to avoid bad effect due to high temperature, do not install the controller near heat generating sources. If the controller is kept near any heat generating source, measurement goes wrong and finally the life of the product is shortened. Take care about the surrounding temperature of the controller.

Avoid places where there is wind and sudden temperature change, it also causes an error in measurement. Take necessary measures to avoid such surrounding environment.

##### **6. Unused terminal**

Do not connect anything to the unused terminal. Product may get out of order.

##### **7. Countermeasures against erroneous output when power is supplied**

When power is supplied, sometimes the output related signal may be momentarily output when the controller is starting normally. Take the necessary countermeasures by using an external circuit.

# 5. Name of various parts

## 5-1. Entire overview

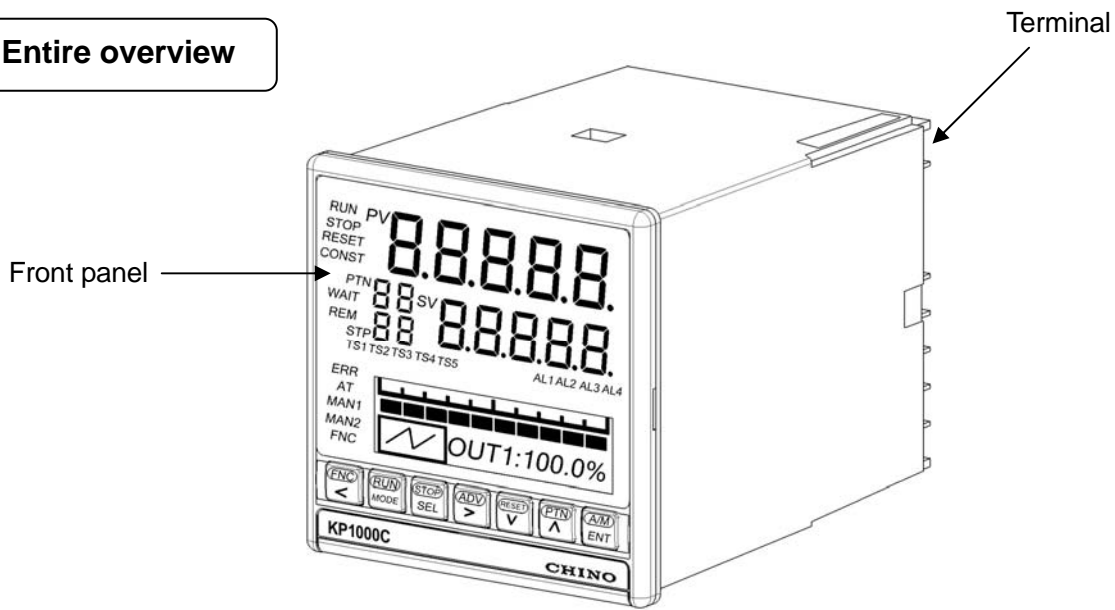

## 5-2. Overview of the front panel

**⚠ Precaution**  
 This internal rack fixing screw is used at the time of maintenance. Customers please do not touch it.

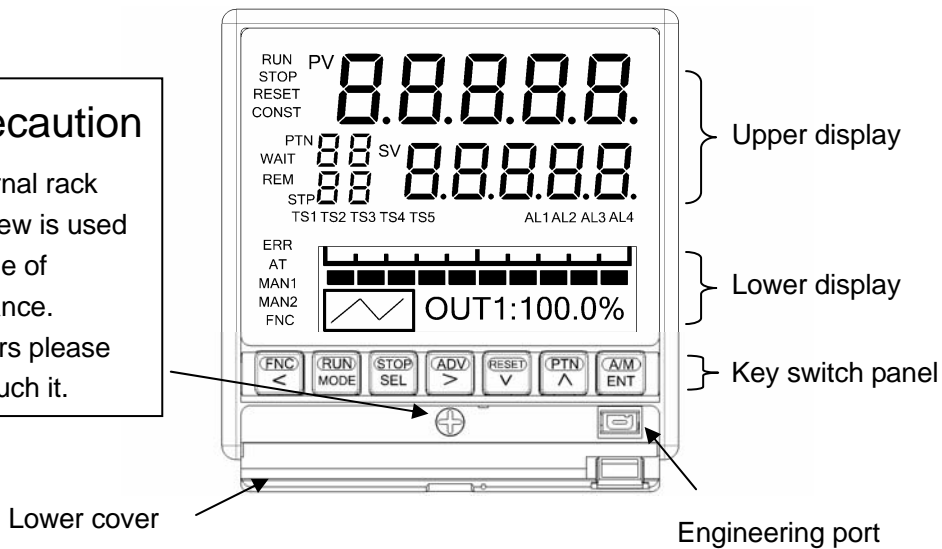



Name	Function
Upper display window	Displays PV, SV and each status.
Lower display window	Displays operation screen and settings screen.
Key switch panel	It is used for each setting. When power is supplied or any of the key is clicked key back light (blue) lights (At the time of initial settings). When no key operation is done for approximately 30 seconds or more, the back light goes off automatically. This back light is illuminated till the end and brightness is uneven hence the blue color has a bright part.. However it does not hinder the functionality of the product hence use it as it is.
Engineering port	Settings from PC can be done after connecting the exclusive engineering cable.
Lower cover	When using engineering port open the lower cover. At other times keep it closed tightly.

## 5-3 Front Details

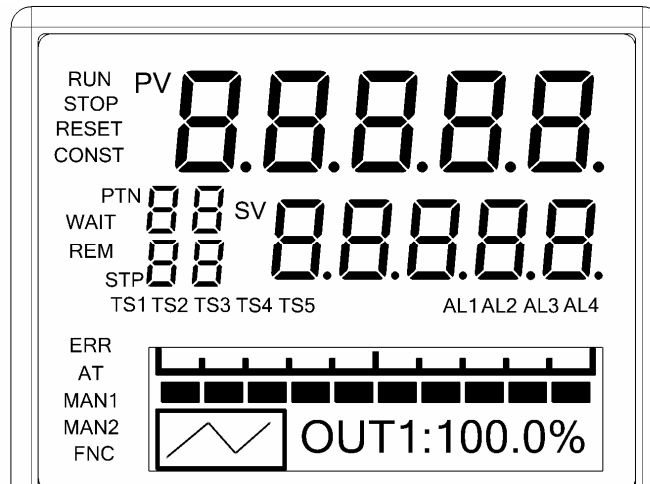
### 5-3-1 Upper display























Name	Function
PV	Displays PV (measurement value).
SV	Displays SV (setting value).
PTN	Displays the pattern number that is being selected. Blink when PTA is changed.
STP	Displays the step number that is being executed. At the time of real temperature compensation operation, the numeral of the number blinks.
RUN	Lights during RUN status. Blink when condition is FAST.
STOP	Lights during STOP status. Blink when condition is WAIT for external signal input.
RESET	Lights during RESET status.
CONST	Lights during constant value operation.
WAIT	Lights when alarm output is released (reset). Lights during the wait status during the wait alarm. Blinks at the time of waiting time alarm activation.
REM	Lights during the run operation due to external drive input. (Lights when selected except 'MASTER KEY' in 'program drive system' of mode 1 of specifications with external drive input only, and lights when selected except 'KEY' in 'pattern selection mode' )
ERR	Lights in case of abnormality in taking the input.
AT	Lights during auto tuning operation.
MAN1	Lights when output 1 is manual output operation.
MAN2	Lights when output 2 is manual output operation.
TS1-TS8	Lights when time signal from TS1 to TS5 is ON.
AL1-AL4	Lights when alarm from AL1 to AL4 is ON.
FNC	Lights when  key is clicked. It is operation key mode when FNC lights. If  key is switched again, lights of FNC are switched OFF.



### 5-3-2. Key switch panel





Name	Function
	<ul style="list-style-type: none"> <li>• If this key is clicked in case of operation screen, it is run operation key mode. (For example, in operation screen if  key is clicked after clicking the  key, it becomes RUN status.)</li> <li>• If this key is clicked in case of setting screen, it is setting operation key mode and operates to move the cursor backwards.</li> </ul>
	<ul style="list-style-type: none"> <li>• In case of run operation key mode, it operates as RUN key. (For example, in operation screen, if  key is clicked after clicking the  key, it becomes the RUN status.)</li> <li>• If this key is clicked in case of setting screen, it is setting operation key mode and it is used in switching between operation screen and mode 0 of mode screen, and from setting screen to mode screen.</li> </ul>
	<ul style="list-style-type: none"> <li>• In case of run operation key mode, it operates as STOP key. (For example, in operation screen, if  key is clicked after clicking the  key, it becomes STOP status.)</li> <li>• If this key is clicked in case of operation screen, it is used in switching of operation screen. If this key is clicked in case of setting screen, it becomes the setting operation key mode and is used in switching of setting screen.</li> </ul>
	<ul style="list-style-type: none"> <li>• In case of operation key mode, it operates as ADV key. (For example, in operation screen, if  key is clicked after clicking the  key, it becomes the advance operation.)</li> <li>• If this key is clicked in case of settings screen, it becomes setting operation key mode and is used in cursor forwarding and selecting items.</li> </ul>
	<ul style="list-style-type: none"> <li>• In case of operation key mode, it operates as RESET key. (For example, in operation screen if  key is clicked after clicking the  key, it becomes the RESET status.)</li> <li>• If this key is clicked in case of settings screen, it becomes the settings operation key mode and is used in descending order of setting value (set items).</li> </ul>
	<ul style="list-style-type: none"> <li>• In case of run operation key mode, it operates as PTN key. (For example, in operation screen, during RESET, if  key is clicked after clicking the  key, it becomes the pattern number selection status. At that time screen display of PTN blinks.)</li> <li>• If this key is clicked in case of setting screen, it becomes the settings operation key mode and is used in ascending order of set value ( or set items).</li> </ul>
	<ul style="list-style-type: none"> <li>• In case of operation key mode, it operates as A/M key. (For example in operation screen of output display, during automatic output operation, if  key is clicked after clicking the  key, it becomes manual output operation status.)</li> <li>• If this key is clicked in case of setting screen, it becomes the settings operation key mode and is used in registering the settings.</li> </ul>



## 6. Operation screen

In case of lower display, operation screen and settings screen are displayed however, output screen has an output display screen whose display contents differ depending on the output format of the product, a time display screen that displays the progress time of program pattern, and an overall display screen.

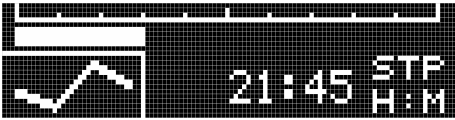
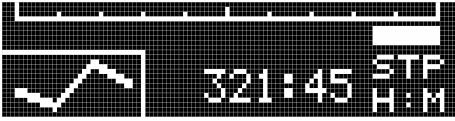

### 6-1. Output display screen

Output display screen	Description of screen
<p>[ON-OFF pulse type] [SSR drive pulse type]</p>  <p>※The above is a dummy display, actually, <b>OFF</b> and <b>ON</b> do not illuminate simultaneously.</p>	<ol style="list-style-type: none"> <li>① On the left bottom, a snap display of three steps, the executing step in the middle and its previous and the next step are displayed. In case of RUN status, the executing step in the middle blinks.</li> <li>② When output is ON, <b>ON</b> lights and when output is OFF, <b>OFF</b> lights.</li> <li>③ Displays MV (output value) digitally.</li> <li>④ In case of manual output operation (manual output), 'M' is displayed on the right side of 'OUT'.</li> </ol>
<p>[Current output type] [Voltage output type]</p> 	<ol style="list-style-type: none"> <li>① On the left bottom, a snap display of three steps, the executing step in the middle and its previous and the next step are displayed. In case of RUN status, the executing step in the middle blinks.</li> <li>② Displays bar graph corresponding to the output value.</li> <li>③ Displays MV (output value) digitally.</li> <li>④ In case of manual output operation (manual output), 'M' is displayed on the right side of 'OUT'.</li> </ol>
<p>[ON-OFF servo type]</p>  <p>※The above is a dummy display, actually, <b>CLOSE</b> and <b>OPEN</b> do not illuminate simultaneously.</p>	<ol style="list-style-type: none"> <li>① On the left bottom, a snap display of three steps, the executing step in the middle and its previous and the next step are displayed. In case of RUN status, the executing step in the middle blinks.</li> <li>② When close side signal is ON <b>CLOSE</b> lights and when open side signal is ON <b>OPEN</b> lights. When both the signals are OFF nothing is illuminated.</li> <li>③ Displays MV (output value) digitally.</li> <li>④ Displays feedback value (extent of valve opening) digitally.</li> <li>⑤ In case of manual output operation (manual output), 'M' is displayed on the left side of 'OUT'.</li> </ol>

## 6-2 Time display screen



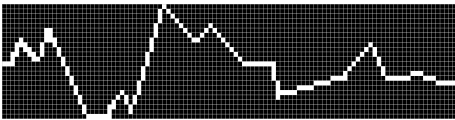
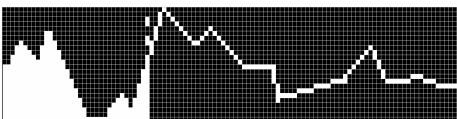

Time display screen	Description of screen
<p><b>[Elapsed time display]</b></p>  <p><b>[Remaining time display]</b></p> 	<ol style="list-style-type: none"> <li>① On the left bottom, a snap display of three steps, the executing step in the middle and its previous and the next step are displayed. In case of RUN status, the executing step in the middle blinks.</li> <li>② On the upper side is the bar graph corresponding to the progress time of program pattern and on the lower right its progress time is displayed digitally.</li> <li>③ Progress time selects arbitrarily from four types from [Time display system] of mode 1. <ul style="list-style-type: none"> <li>STP···Executing step display</li> <li>PTN···Executing pattern display</li> </ul>                     Time format (H:M) is automatically changed/displayed depending on the length of time of pattern or step.                      Time display format can also be changed by using  key.                 </li> </ol>

## 6-3 Program pattern overall display screen

Time display screen	Description of screen
<p><b>[Condition of program RESET]</b></p>  <p><b>[Condition of program RUN]</b></p>  <p><b>[Condition of program unsetting]</b></p> 	<ol style="list-style-type: none"> <li>① It is program pattern which is set at mode 2, and brief program pattern of selected setting number is displayed.</li> <li>② When it is Run condition, blinking bar is displayed and the bar moves according to status.</li> <li>③ If put in the STOP condition, bar is turned blink to light and stop when program is stopped.</li> <li>④ Indicate horizontal axis is time and vertical axis is SV. When program pattern is not set, display [PATTERN NO SETTING].</li> </ol>

## 6-4. Output display screen of output 2 specifications

For output 2 specifications, unlike output display screen of normal output 1 specifications, output display screen is displayed for each output.

Output display screen of output 1	Output display screen of output 2
<p>[ON-OFF pulse type] [SSR drive pulse type]</p> 	<p>[ON-OFF pulse type] [SSR drive pulse type]</p> 
<p>[Current output type] [Voltage output type]</p> 	<p>[Current output type] [Voltage output type]</p> 
<p>① Operation screen of output 1 becomes 'OUT1' after adding '1' on the right of 'OUT' and thus indicates that it is an operation screen for output 1. Similarly, operation screen of output 2 becomes 'OUT2' after adding '2' on the right of 'OUT' and thus indicates that it is an operation screen for output 2.</p> <p>② Switch the output 1 operation screen and output 2 operation screen by using  key.</p>	

## 6-5. Operation screen and setting screen

Relation between operation screen and settings screen is as follows.

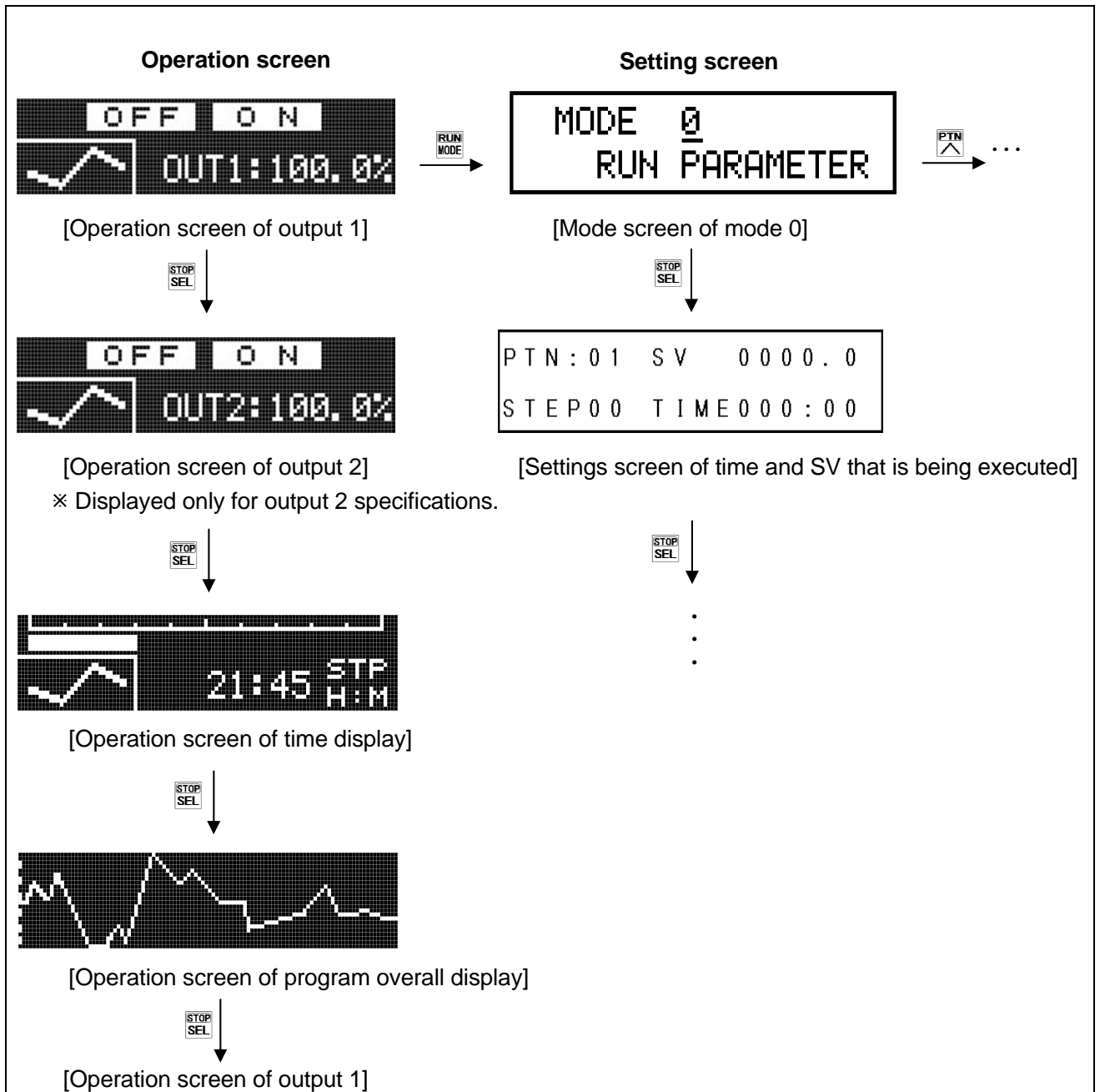



- ① When power is supplied and after initial message is displayed first of all the operation screen is displayed.
- ② In the settings screen if no key operation is done for around three minutes or more, it automatically returns to the operation screen.  
However, for 'auto tuning' settings screen of mode 1, when auto tuning is executing etc., it may sometimes not return to the automatic operation screen.
- ③ Operation screen displayed lastly (either of output display screen, time display screen, or program pattern overall display screen) is stored and that operation screen is displayed after returning from power supply insertion or settings screen.

# 7. Setting screen

## 7-1. Basics of setting

### 7-1-1. Call up the setting screen

- ① Setting screen is grouped for every mode as mentioned in '1.8 Parameter directory list table'. Confirm number and the mode of the settings screen that is to be call up.
- ② Switching between operation screen and mode screen is done by  key, mode screen is selected by  key and setting screen is selected by using  key from mode screen respectively.

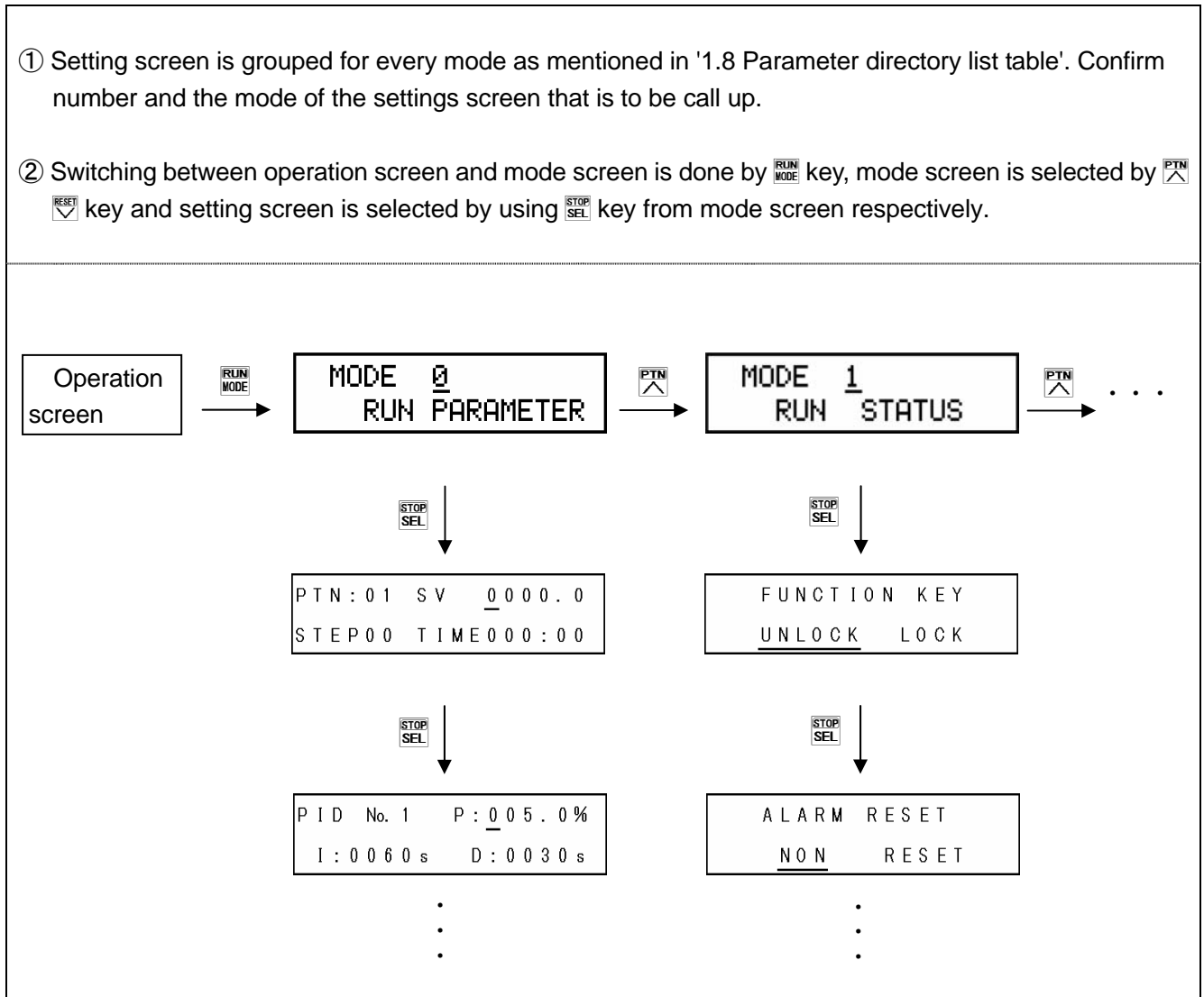

## 7-1-2. Basic operation of settings screen

In the settings screen, numeric value is changed and field is selected by using  $\boxed{\text{ADV}} \boxed{\text{PTN}} \boxed{\text{RESET}} \boxed{\text{V}}$  key and settings are completed by clicking  $\boxed{\text{A/M}} \boxed{\text{ENT}}$  key.



Example of basic operation	
<p>1. Example of setting a numeric value</p> <div style="border: 1px solid black; padding: 5px; width: fit-content;">           P I D No. 1 P : 0 0 5 . 0 %            I : 0 0 6 0 s D : 0 0 3 0 s         </div>	<p>① By using <math>\boxed{\text{ADV}} \boxed{\text{FNC}}</math> key the cursor is moved to the digit whose numeric value that is to be changed..</p> <p>② By using <math>\boxed{\text{PTN}} \boxed{\text{RESET}} \boxed{\text{V}}</math> key the desired numeric value is selected. At that time, '?' mark is put.</p> <p>③ The value is registered by using the <math>\boxed{\text{A/M}} \boxed{\text{ENT}}</math> key. At that time '?' disappears.</p>
<p>2. Example (1) of setting a field</p> <div style="border: 1px solid black; padding: 5px; width: fit-content;">           INPUT KIND            0 5 K 1         </div>	<p>① By using <math>\boxed{\text{PTN}} \boxed{\text{RESET}} \boxed{\text{V}}</math> key the desired field is selected. At that time '?' mark is put.</p> <p>② The field is registered by using the <math>\boxed{\text{A/M}} \boxed{\text{ENT}}</math> key. At that time '?' mark disappears.</p>
<p>3. Example (2) of setting a field</p> <div style="border: 1px solid black; padding: 5px; width: fit-content;">           MEASURE UNIT            ° C K         </div>	<p>① By using <math>\boxed{\text{ADV}} \boxed{\text{FNC}}</math> key the desired field is selected. At that time '?' mark is put.</p> <p>② The field is registered by using the <math>\boxed{\text{A/M}} \boxed{\text{ENT}}</math> key. At that time '?' mark disappears.</p>

A convenient key operation method is given below in order to speed up the settings operation more.

<p>1. Fast forwarding the cursor</p> <p>① Usually, cursor moves by one digit by using <math>\boxed{\text{ADV}} \boxed{\text{V}}</math> key, however by using the <math>\boxed{\text{A/M}} \boxed{\text{ENT}}</math> key, the cursor can be moved by, set field unit.</p> <p>② For example in the following PID settings screen, when <math>\boxed{\text{A/M}} \boxed{\text{ENT}}</math> key is clicked, the cursor moves as shown below.</p> <div style="text-align: center; margin: 10px 0;"> <p>'No.'</p> <div style="display: flex; align-items: center; justify-content: center;"> <div style="border: 1px solid black; padding: 5px; margin-right: 10px;">           P I D No. 1 P : 0 0 5 . 0 %            I : 0 0 6 0 s D : 0 0 3 0 s         </div> <div style="font-size: 2em; margin-right: 10px;">→</div> <div style="border: 1px solid black; padding: 5px; margin-left: 10px;">           P I D No. 1 P : 0 0 5 . 0 %            I : 0 0 6 0 s D : 0 0 3 0 s         </div> </div> <p style="margin-top: 10px;">↑ <math>\boxed{\text{A/M}} \boxed{\text{ENT}}</math> ↓ <math>\boxed{\text{A/M}} \boxed{\text{ENT}}</math></p> <div style="display: flex; justify-content: space-around; margin-top: 10px;"> <div style="text-align: center;"> <p>'Left most digit of the numeric value of D that is set'</p> <div style="border: 1px solid black; padding: 5px; width: fit-content;">           P I D No. 1 P : 0 0 5 . 0 %            I : 0 0 6 0 s D : 0 0 3 0 s         </div> </div> <div style="text-align: center;"> <p>'Left most digit of the numeric value of I that is set'</p> <div style="border: 1px solid black; padding: 5px; width: fit-content;">           P I D No. 1 P : 0 0 5 . 0 %            I : 0 0 6 0 s D : 0 0 3 0 s         </div> </div> </div> <p style="margin-top: 10px;">← <math>\boxed{\text{A/M}} \boxed{\text{ENT}}</math></p> </div>
<p>2. Rewinding the cursor</p> <p>Usually by using the <math>\boxed{\text{ADV}} \boxed{\text{V}}</math> key, the cursor moves by one digit from left to right, however by clicking the <math>\boxed{\text{FNC}} \boxed{\text{V}}</math> key, the cursor can be moved from right to left.</p>

## 7-2. Mode 0

Mode 0 changes the setting of main parameters that are being executed.





Settings screen	Description of the screen
<p>1. Mode screen</p> <div style="border: 1px solid black; padding: 5px; width: fit-content; margin: 5px 0;">           MODE 0            RUN PARAMETER         </div> <p>[Lock status]</p> <div style="border: 1px solid black; padding: 5px; width: fit-content; margin: 5px 0;">           MODE 0 Lock            RUN PARAMETER         </div> <p>[Display OFF status]</p> <div style="border: 1px solid black; padding: 5px; width: fit-content; margin: 5px 0;">           MODE 0 NoDisp            RUN PARAMETER         </div>	<ol style="list-style-type: none"> <li>① Mode 0 screen.</li> <li>② By clicking the   key, 'Lock' and 'NoDisp' is displayed.</li> <li>③ For mode 0 settings screen, if setting change is to be prohibited select 'Lock'.</li> <li>④ When doing the settings by communications, set all the mode screens to 'Lock'.</li> <li>⑤ When settings screen of mode 0 is not displayed, 'NoDisp' is displayed.</li> </ol>
<p>2.SV that is being executed and time</p> <div style="border: 1px solid black; padding: 5px; width: fit-content; margin: 5px 0;">           PTN:01 SV 0000.0            STEP00 TIME000:00         </div>	<ol style="list-style-type: none"> <li>① SV of the executing step and the time can be changed.</li> <li>② Setting range of SV is within the measurement scope of mode 5.</li> <li>③ Change in the setting of this screen is not reflected in the setting contents of 'Program pattern' of mode 2 and is a change only for that time.</li> </ol>
<p>3. PID that is being executed</p> <div style="border: 1px solid black; padding: 5px; width: fit-content; margin: 5px 0;">           PID No.1 P:005.0%            I:0060s D:0030s         </div>	<ol style="list-style-type: none"> <li>① PID of the executing step can be changed.</li> <li>② Change in the setting of this screen is not reflected in the setting contents of '16 types PID' of mode 3 and is a change only for that time.</li> </ol>
<p>4. Output 2 PID that is being executed</p> <div style="border: 1px solid black; padding: 5px; width: fit-content; margin: 5px 0;">           OUT2 PID P:005.0%            I:0060s D:0030s         </div>	<ol style="list-style-type: none"> <li>① Displayed only output 2 specification.</li> <li>② Output 2 PID of the executing step can be changed.</li> <li>③ Change in the setting of this screen is not reflected in the setting contents of 'Output 2 PID' of mode 3 and is a change only for that time.</li> </ol>
<p>5. Alarm 1 and Alarm 2 that are being executed</p> <div style="border: 1px solid black; padding: 5px; width: fit-content; margin: 5px 0;">           ALARM AL1/AL2 No.1            3000.0 / -1999.9         </div>	<ol style="list-style-type: none"> <li>① Alarm 1 and Alarm 2 of the executing step can be changed.</li> <li>② Change in the setting of this screen is not reflected in the setting contents of 'Alarm 1 and Alarm 2' of mode 3 and is a change only for that time.</li> </ol>



<p>6. Alarm 3 and Alarm 4 that are being executed</p> <div style="border: 1px solid black; padding: 5px; width: fit-content;"> ALARM AL3/AL4 No. 1  3000.0 / -1999.9 </div>	<p>① Alarm 3 and Alarm 4 of the executing step can be changed.  ② Change in the setting of this screen is not reflected in the setting contents of 'Alarm 3 and Alarm 4' of mode 3 and is a change only for that time.</p>
<p>7. Output limiter that is being executed</p> <div style="border: 1px solid black; padding: 5px; width: fit-content;"> OUTPUT LIMIT No. 1  L: 000.0% H: 100.0% </div> <p>[Output scale specification]</p> <div style="border: 1px solid black; padding: 5px; width: fit-content;"> OUTPUT SCALE No. 1  L: 000.0% H: 100.0% </div> <p style="text-align: center;">*Option</p>	<p>① Output limiter of the executing step can be changed.  ② Change in the setting of this screen is not reflected in the setting contents of 'Output limiter 8 types' of mode 4 and is a change only for that time.  ③ For output scale specification (option) instead of output limiter, [output scale specification] (right below figure) is displayed.</p>
<p>8. Output variation limiter that is being executed</p> <div style="border: 1px solid black; padding: 5px; width: fit-content;"> OSL UP/DOWN No. 1  100.0% / -100.0% </div>	<p>① Output variation limiter of the executing step can be changed.  ② Change in the setting of this screen is not reflected in the setting contents of 'Output variation limiter 8 types' of mode 4 and is a change only for that time.</p>
<p>9. Sensor correction</p> <div style="border: 1px solid black; padding: 5px; width: fit-content;"> INPUT SHIFT  No. 1 000.00 </div>	<p>① Sensor correction of the executing step can be changed.  ② Change in the setting of this screen is not reflected in the setting contents of 'Sensor correction 8 types' of mode 5 and is a change only for that time.</p>

## 7-3. Mode 1



Mode 1 performs the setting related to operation status.

Settings screen	Description of the screen
<p>1. Mode screen</p> <div data-bbox="212 465 560 555" style="border: 1px solid black; padding: 5px; margin-bottom: 10px;">           MODE 1            RUN STATUS         </div> <p>[Lock status]</p> <div data-bbox="212 629 560 719" style="border: 1px solid black; padding: 5px; margin-bottom: 10px;">           MODE 1 Lock            RUN STATUS         </div> <p>[Display off status]</p> <div data-bbox="212 792 560 882" style="border: 1px solid black; padding: 5px;">           MODE 1 NoDisp            RUN STATUS         </div>	<p>① Mode 1 screen.</p> <p>② By clicking the  ·  key, 'Lock' and 'NoDisp' is displayed.</p> <p>③ For mode 1 settings screen, if setting change is to be prohibited select 'Lock'.</p> <p>④ When doing the settings by communications, set all the mode screens to 'Lock'.</p> <p>⑤ When settings screen of mode 1 is not displayed, 'NoDisp' is displayed.</p>
<p>2. Run operation key lock</p> <div data-bbox="212 1037 560 1126" style="border: 1px solid black; padding: 5px;">           FUNCTION KEY            UNLOCK LOCK         </div>	<p>① Run operation key can be locked.</p> <p>② If 'UNLOCK' is selected, lock is released and  becomes enabled and operation can be done by key.</p> <p>③ If 'LOCK' is selected, lock status,  is disabled and run operation cannot be done by key.</p>
<p>3. Release alarm output</p> <div data-bbox="212 1323 560 1413" style="border: 1px solid black; padding: 5px;">           ALARM RESET            NON RESET         </div>	<p>① In case of temporarily releasing the alarm output that is activated, if 'RESET' is set, alarm output is released.</p> <p>② At that time the cursor immediately returns to 'NON' and WAIT of upper display is illuminated.</p> <p>③ In release (WAIT) status, if you once slip off from alarm activation condition, WAIT becomes non illuminated and you return to the normal status.</p> <p>④ For all the four points of alarm output there is a common setting hence take care.</p>
<p>4. Auto tuning</p> <div data-bbox="212 1765 560 1854" style="border: 1px solid black; padding: 5px;">           PID AUTO TUNING            END AT1 AT2 AT3         </div>	<p>① Performs auto tuning (automatic calculation) of PID.</p> <p>② Set the desired AT type from AT1 to 3 and execute.</p> <ul style="list-style-type: none"> <li>• AT1: AT in SV that is being executed (For output 1).</li> <li>• AT2: AT in 8 types SV for AT2 of mode 3 (For output 1).</li> <li>• AT3: AT in 8 types SV for AT3 of mode 3 (For output 1).</li> </ul> <p>③ If auto tuning is started, AT progress status (STEP 1 to STEP 4) is displayed.</p> <p>④ If you want to stop auto tuning in between, set 'END'.</p> <p>⑤ PID that is calculated by auto tuning can be confirmed by setting screen of each PID.</p>

<p>5. Program drive system</p> <div style="border: 1px solid black; padding: 5px; text-align: center;"> PROGRAM DRIVE SET  MASTER KEY </div>	<ol style="list-style-type: none"> <li>① Only the specifications with external drive input or with communication are displayed.</li> <li>② Set program drive system.</li> <li>③ If 'MASTER KEY' is selected, driving is done by front key.</li> <li>④ If 'MASTER EXT' is selected, driving is done by external drive input, however, it can be selected only for specifications with external drive input.</li> <li>⑤ If 'SLAVE EXT' is selected, driving is done by external drive input synchronized with the others. However, it can be selected only for specifications with external drive input.</li> <li>⑥ If 'MASTER COM' is selected, driving is done by communication. However it can be selected only for specifications with communication.</li> </ol>
<p>6. Pattern selection system</p> <div style="border: 1px solid black; padding: 5px; text-align: center;"> PATTERN SELECT  KEY EXT COM </div>	<ol style="list-style-type: none"> <li>① Only the specifications with external drive input or with communication are displayed.</li> <li>② Pattern selection system is set.</li> <li>③ If 'KEY' is selected, selection is done using front key.</li> <li>④ If 'EXT' is selected, selection is done using external drive signal input. However it can be selected only for specifications with external drive input.</li> <li>⑤ If 'COM' is selected, selection is done using communication. However only the specifications with communication can be selected.</li> </ol>
<p>7. Time display system</p> <div style="border: 1px solid black; padding: 5px; text-align: center;"> TIME DISPLAY SET  PASS STEP </div>	<ol style="list-style-type: none"> <li>① Sets the time display system of operation screen (Time display).</li> <li>② If 'PASS STEP' is selected, elapsed time of the executing step is displayed.</li> <li>③ If 'PASS PATTERN' is selected, elapsed time of executing pattern is displayed.</li> <li>④ If 'REMAIN STEP' is selected, remaining time of the executing step is displayed.</li> <li>⑤ If 'REMAIN PATTERN' is selected, remaining time of executing pattern is displayed.</li> <li>⑥ In the time display screen of section 6-2, time display system can also be changed by  key.</li> </ol>
<p>8. Control format</p> <div style="border: 1px solid black; padding: 5px; text-align: center;"> CONTROL MODE  PROGRAM CONST </div>	<ol style="list-style-type: none"> <li>① Set the control format.</li> <li>② If 'PROGRAM' is selected, it becomes the program operation.</li> <li>③ If 'CONST' is selected, it becomes a constant value operation. When the program is operating if constant value operation is considered, then it becomes a constant value operation in SV.</li> </ol>



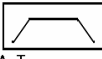

## 7-4. Mode 2

Mode 2 performs the setting related to SV.

Settings screen	Description of the screen
<p>1. Mode screen</p> <div data-bbox="212 456 563 546" style="border: 1px solid black; padding: 5px; margin-bottom: 10px;">           MODE 2 PATTERN / STEP         </div> <p>[Lock status]</p> <div data-bbox="212 618 563 707" style="border: 1px solid black; padding: 5px; margin-bottom: 10px;">           MODE 2 Lock PATTERN / STEP         </div> <p>[Display OFF status]</p> <div data-bbox="212 779 563 869" style="border: 1px solid black; padding: 5px;">           MODE 2 NoDisp PATTERN / STEP         </div>	<p>① Mode 2 screen.</p> <p>② By clicking the  ·  key, 'Lock' and 'No Disp' is displayed.</p> <p>③ For mode 2 settings screen, if setting change is to be prohibited select 'Lock'.</p> <p>④ When doing the settings by communications, set all the mode screens to 'Lock'.</p> <p>⑤ When settings screen of mode 2 is not displayed, select 'NoDisp'.</p>
<p>2. Program pattern</p> <div data-bbox="212 1151 563 1240" style="border: 1px solid black; padding: 5px; margin-top: 10px;">           PTN:01 SV 0000.0 STEP00 START : SV         </div>	<p>① Set the time and SV which is the basis of program pattern.</p> <p>② 'PTN' indicates (program) pattern, pattern numbers from 01 to 19 can be set. Select an arbitrary number and set the pattern.</p> <p>③ 'STEP' indicates step and maximum 19 steps can be set for each pattern.</p> <p>④ Set a target SV, such that 'SV' finally reaches that step. When measurement range, unit, measurement scope, linear scale etc. is changed, sometimes the decimal point position changes automatically and relatively hence take care.</p> <p>⑤ 'TIME' sets the time required for that step. Unit can be set by 'time unit' of mode 2, either of 'Hours:Minutes' or 'Minutes:Seconds' can be selected.</p> <p>⑥ Setting procedure is as follows.</p> <ul style="list-style-type: none"> <li>▪ Select pattern number.</li> <li>▪ In step number 00, set setting value of start SV in 'SV' and set start system below it. Start system selects either 'SV' or 'PV'. If 'SV' is selected, it becomes SV start operation and if 'PV' is selected, it becomes PV start operation.</li> <li>▪ Consider step number 01 and set SV and time of the initial step. Setting range of SV is within the scope of measurement of mode 5. Setting range of TIME is within the range '000:00' to '999:59'. By setting '000:00', momentarily (step wise) SV can also be considered.</li> <li>▪ Similarly for next step onwards, set SV and TIME and combine it with the desired program pattern.</li> </ul>



	<ul style="list-style-type: none"> <li>• This procedure becomes a system called target SV system that exists in target specifications. In option there is a thing called slope SV system. In case of this system, set in 'SV' the SV variation quantity for each unit time. and set the time in 'TIME' until which that SV variation can continue.</li> <li>• Combine with the desired program pattern and when you want to exit the setting, set 'END/LINK00' in TIME of last step number and thus end the pattern setting. In the initial setting status 'END/LINK00' is always set in the last step.</li> <li>• When you want to link (link another pattern) a pattern, set the pattern number that is to be linked, in '00' on the right of LINK of 'END/LINK00' of the last step and click the  key. When link several patterns and link from end pattern to first pattern or set one of the pattern linked itself, become endless (endless loop). Then pattern repeat is not effected.</li> <li>• If you want to delete a certain step, set 'STEPDELETE' in TIME of step number that is to be deleted. The contents of that step get deleted and the step numbers from next step onwards are automatically updated.</li> <li>• If you want to insert a certain step, set 'STEPINSERT' in TIME of step number that is to be inserted. The contents which is same as each parameter of selected step get inserted and the step numbers from next step onwards are automatically updated.</li> </ul>
<p>3. Repeat step</p> <div data-bbox="210 1227 561 1317" style="border: 1px solid black; padding: 5px;"> <p>PTN : 01 </p> <p>STEP01 REPEAT :</p> </div>	<ol style="list-style-type: none"> <li>① Set step repeat.</li> <li>② It is a convenient function if you want to repeat a specific step section in an identical pattern.</li> <li>③ Set '00' in REPEAT of start repeat step number and set 'repeat count' in REPEAT of end repeat step number. If 01 is set, the step repeat section that is set is repeated once, hence the entire identical step section is run twice.</li> <li>④ In identical pattern, step repeat settings can be done any number of times. However duplication of repeat section and, small repetitions within large repetitions cannot be set. When setting a number of sets of step repeat, set in such a way that the '00' and repeat count settings always pair alternately in the pattern.</li> <li>⑤ On the upper right part of this setting screen, snap format of step that is being set is displayed.</li> </ol>
<p>4. PID number and alarm number</p> <div data-bbox="210 1960 561 2049" style="border: 1px solid black; padding: 5px;"> <p>PTN : 01 PID.....No. 1</p> <p>STEP01 ALARM...No. 1</p> </div>	<ol style="list-style-type: none"> <li>① Set the PID number and alarm number for each pattern/step that are set.</li> <li>② Set PID number from 1 to 9 and alarm number from 1 to 8. Number 0 can also be set. When 0 is set, it becomes a function for continuing with the same step number as that of the previous step.</li> </ol>

<p>5. Output limiter no. and output variation limiter number</p> <div style="border: 1px solid black; padding: 5px; margin: 10px 0;"> PTN: 01 OPL.....No. 1  STEP01 OSL.....No. 1 </div> <p>[Output scale specifications]</p> <div style="border: 1px solid black; padding: 5px; margin: 10px 0;"> PTN: 01 OPS.....No. 1  STEP01 OSL.....No. 1 </div> <p style="text-align: center;">※ Option</p>	<ol style="list-style-type: none"> <li>① Set output limiter number and output variation limiter number for each pattern/step that is set.</li> <li>② Set anything from number 1 to 8 for both. Number 0 can also be set. When 0 is set, it becomes a function for continuing with the same step number as that of the previous step.</li> <li>③ In case of output scale specification (option), the screen is, as shown on the lower left.</li> </ol>
<p>6. Sensor correction number</p> <div style="border: 1px solid black; padding: 5px; margin: 10px 0;"> PTN: 01 INPUT SHIFT  STEP01 No. 1 </div>	<ol style="list-style-type: none"> <li>① Set sensor correction number for each pattern/step that is set.</li> <li>② Set from number 1 to 8. Number 0 can also be set. When 0 is set, it becomes a function for continuing with the same step number as that of the previous step.</li> </ol>
<p>7. Time signal number</p> <div style="border: 1px solid black; padding: 5px; margin: 10px 0;"> PTN: 01 TIME SIGNAL  STEP01 TS1 No. OFF </div>	<ol style="list-style-type: none"> <li>① Display only time signal specification.</li> <li>② For every pattern/step that is set, time signal output destination and time signal number to be used is set.</li> <li>③ Set time signal output destination in 'TS' and time signal number in 'No.'.</li> <li>④ Set time signal number from number 1 to 8, number 1R-8R, ON and OFF. The 'R' after number is for repeating the time signal and only during that step, is a function where in time signal of that number repeats with identical setting value. 'ON' means everything ON and 'OFF' means everything OFF.</li> </ol>
<p>8. Real temperature compensation number</p> <div style="border: 1px solid black; padding: 5px; margin: 10px 0;"> PTN: 01 GUARAN. SOAK  STEP01 No. OFF </div>	<ol style="list-style-type: none"> <li>① Set real temperature compensation number for every pattern/step that is set.</li> <li>② Set from number 1 to 8 and OFF. 'OFF' is a setting where in real temperature compensation does not operate.</li> </ol>
<p>9. Waiting time alarm number</p> <div style="border: 1px solid black; padding: 5px; margin: 10px 0;"> PTN: 01 WAIT TIMER  STEP01 No. 1 </div>	<ol style="list-style-type: none"> <li>① Set waiting time alarm number for every pattern/step that is set.</li> <li>② Set from number 1 to 8. Number 0 can also be set. When 0 is set, it becomes a function for continuing with the same step number as that of the previous step.</li> </ol>

<p>10. Pattern repeat</p> <div style="border: 1px solid black; padding: 5px; width: fit-content; margin: 10px auto;"> <p style="text-align: center;">PATTERN REPEAT 0 0 0 0</p> </div>	<ol style="list-style-type: none"> <li>① Set pattern repeat (repeat).</li> <li>② If you want to repeat the program pattern of same pattern number, it is a very convenient function.</li> <li>③ When '0001' is set, same pattern is repeated once. Hence on a whole, the same pattern is run twice. Pattern repeat is not only for the executing pattern, but as this setting value is always enabled, take care.</li> </ol>
<p>11. Pattern clear</p> <div style="border: 1px solid black; padding: 5px; width: fit-content; margin: 10px auto;"> <p style="text-align: center;">PATTERN CLEAR END EACH: 01 ALL</p> </div>	<ol style="list-style-type: none"> <li>① It is a function that clears (deletes) the pattern that is set.</li> <li>② When clearing the specified pattern number, set the pattern number that is to be cleared, on the right side of 'EACH:' and click the  key.</li> <li>③ When clearing all the pattern numbers that are set, move the cursor to 'ALL' and click the  key.</li> <li>④ When flashing is clear by clicking  key for while, and cursor return to "END", clear (delete) is executed.</li> <li>⑤ Executing pattern cannot be cleared.</li> <li>⑥ Cleared pattern number cannot be restored, hence take care.</li> </ol>
<p>12. Copy pattern</p> <div style="border: 1px solid black; padding: 5px; width: fit-content; margin: 10px auto;"> <p style="text-align: center;">PATTERN COPY END PTN: 01 → 02 YES</p> </div>	<ol style="list-style-type: none"> <li>① It is a function of copying the optional pattern number that is set, in pattern number which is not set.</li> <li>② Set the pattern number of copy source on the left side of and pattern number of copy destination on the right side '→', move the cursor to 'YES' and click  key.</li> <li>③ Copy function cannot be performed on the pattern number that is set, hence if you want to copy on the pattern number that is already set, clear that pattern and then copy.</li> </ol>
<p>13. SV at the time of resetting</p> <div style="border: 1px solid black; padding: 5px; width: fit-content; margin: 10px auto;"> <p style="text-align: center;">PROGRAM RESET SV 0 0 0 0 . 0</p> </div>	<ol style="list-style-type: none"> <li>① It is displayed in case of specifications with transmission signal output or specifications with communication and when selecting [TRANS] function.</li> <li>② Sets the SV at the time of resetting.</li> <li>③ When selecting 'SV' by transmission type, the transmission value at the time of resetting becomes this setting value.</li> </ol>
<p>14. Time unit</p> <div style="border: 1px solid black; padding: 5px; width: fit-content; margin: 10px auto;"> <p style="text-align: center;">PROGRAM TIME UNIT HOUR: MIN MIN: SEC</p> </div>	<ol style="list-style-type: none"> <li>① Set a common time unit related to program pattern, time signal and waiting time alarm.</li> <li>② If 'HOUR:MIN' is selected it becomes hour and minute.</li> <li>③ If 'MIN:SEC' is selected, it becomes minute and second.</li> <li>④ This setting cannot be changed when the program is running.</li> </ol>

## 7-5. Mode 3

Mode 3 performs the setting related to PID and alarm.

Settings screen	Description of the screen
<p>1. Mode screen</p> <div data-bbox="212 499 560 589" style="border: 1px solid black; padding: 5px; margin-bottom: 10px;">           MODE 3 PID / ALARM         </div> <p>[Lock Status]</p> <div data-bbox="212 663 560 752" style="border: 1px solid black; padding: 5px; margin-bottom: 10px;">           MODE 3 Lock PID / ALARM         </div> <p>[Display OFF status]</p> <div data-bbox="212 826 560 916" style="border: 1px solid black; padding: 5px;">           MODE 3 NoDisp PID / ALARM         </div>	<p>① Mode 3 screen.</p> <p>② By clicking the  ·  key, 'Lock' and 'NoDisp' is displayed.</p> <p>③ For mode 3 settings screen, if setting change is to be prohibited select 'Lock'.</p> <p>④ When doing the settings by communications, set all the mode screens to 'Lock'.</p> <p>⑤ When settings screen of mode 3 is not displayed, select 'NoDisp'.</p>
<p>2. 16 types PID</p> <div data-bbox="212 1048 560 1137" style="border: 1px solid black; padding: 5px;">           PID No.1 P:005.0% I:0060s D:0030s         </div>	<p>① Set all 16 types of PID from 1-8 and from 9-1 to 9-8.</p> <p>② Numbers 9-1 to 9-8 correspond to automatic PID switching system.</p> <p>③ By setting P to 0%, it becomes two-position control operation.</p> <p>④ If I is set to 0s, it is equivalent to <math>\infty</math> and if D is set to 0s, it is equivalent to OFF.</p> <p>⑤ After the settings, it is necessary to set the PID number that is to be used for each pattern/step in mode 2.</p>
<p>3. A.R.W.</p> <div data-bbox="212 1395 560 1485" style="border: 1px solid black; padding: 5px;">           A . R . W . L - 0 5 0 . 0 % H 0 5 0 . 0 %         </div>	<p>① Set ARW (Anti reset windup).</p> <p>② For PID control, it is a function for deciding the range of PID operation. If this setting value is exceeded, it becomes a PD operation.</p> <p>③ Setting value is percentage (%) of measurement scope (including linear scale).</p> <p>④ This function works only for position type PID control.</p>
<p>4. Output 2 PID</p> <div data-bbox="212 1742 560 1832" style="border: 1px solid black; padding: 5px;">           OUT2 PID P:005.0% I:0060s D:0030s         </div>	<p>① This is displayed only for output 2 specification.</p> <p>② Set the PID for output 2.</p> <p>③ By setting P to 0%, it becomes two-position control operation.</p> <p>④ If I is set to 0s, it is equivalent to <math>\infty</math> and if D is set to 0s, it is equivalent to OFF.</p>
<p>5. Output 2 gap</p> <div data-bbox="212 2011 560 2101" style="border: 1px solid black; padding: 5px;">           OUT1-OUT2 GAP 000.0%         </div>	<p>① This is displayed only for output specification.</p> <p>② Set the gap between output 1 and output 2.</p>





<p>6. Output dead band</p> <div style="border: 1px solid black; padding: 5px; width: fit-content; margin: 10px auto;"> <p>P = 0 D . B A N D 0 . 5 %</p> </div>	<ol style="list-style-type: none"> <li>① Set output dead band</li> <li>② Set output dead band of two-position control operation (When P=0%).</li> <li>③ Output dead band of two-position control operation becomes a dead band at the time of output ON/OFF.</li> </ol>
<p>7. Output 2 dead band</p> <div style="border: 1px solid black; padding: 5px; width: fit-content; margin: 10px auto;"> <p>OUT 2 P = 0 D . B A N D 0 . 5 %</p> </div>	<ol style="list-style-type: none"> <li>① This is displayed only for output 2 specification.</li> <li>② Set output dead band for output 2.</li> <li>③ Set output dead band of two-position control operation (When P=0%).</li> <li>④ Output dead band of two-position control operation becomes a dead band at the time of output ON/OFF.</li> </ol>
<p>8. Alarm format</p> <div style="border: 1px solid black; padding: 5px; width: fit-content; margin: 10px auto;"> <p>ALARM 1 : DH 2 : DL MODE 3 : DH 4 : DL</p> </div>	<ol style="list-style-type: none"> <li>① Set the alarm format of alarm 1-4 (AL1-AL4).</li> <li>② There are 8 types of alarm formats as shown below. Set the respective types for AL1 to AL4. <ul style="list-style-type: none"> <li>• DH : Deviation higher limit alarm</li> <li>• DHW : Waiting deviation higher limit alarm</li> <li>• DL : Deviation lower limit alarm</li> <li>• DLW : Waiting deviation lower limit alarm</li> <li>• AH : Absolute value higher limit alarm</li> <li>• AHW : Waiting absolute value higher limit alarm</li> <li>• AL : Absolute value lower limit alarm</li> <li>• ALW : Waiting absolute value lower limit alarm</li> </ul> </li> </ol>
<p>9. Alarm 1 and Alarm 2, 8 types</p> <div style="border: 1px solid black; padding: 5px; width: fit-content; margin: 10px auto;"> <p>ALARM AL1 / AL2 No. 1 3 0 0 0 . 0 / - 1 9 9 9 . 9</p> </div>	<ol style="list-style-type: none"> <li>① Set 8 types of settings values of alarm 1 and alarm 2.</li> <li>② After the settings, it is necessary to set the alarm number that is to be used for each pattern/step in mode 2.</li> <li>③ When measurement range, unit, measurement scope, linear scale, etc is changed, sometimes the setting range and decimal point position changes automatically and relatively, hence take care.</li> </ol>
<p>10. Alarm 3 and Alarm 4, 8 types</p> <div style="border: 1px solid black; padding: 5px; width: fit-content; margin: 10px auto;"> <p>ALARM AL3 / AL4 No. 1 3 0 0 0 . 0 / - 1 9 9 9 . 9</p> </div>	<ol style="list-style-type: none"> <li>① Set 8 types of settings values of alarm 3 and alarm 4.</li> <li>② After the settings, it is necessary to set the alarm number that is to be used for each pattern/step in mode 2.</li> <li>③ When measurement range, unit, measurement scope, linear scale, etc is changed, sometimes the setting range and decimal point position changes automatically and relatively, hence take care.</li> </ol>
<p>11. Alarm dead band</p> <div style="border: 1px solid black; padding: 5px; width: fit-content; margin: 10px auto;"> <p>ALARM D . B A N D AL1 0 0 2 . 0 0</p> </div>	<ol style="list-style-type: none"> <li>① Set alarm dead band of alarm 1 to 4.</li> <li>② Unit is same as the setting value of respective alarm.</li> <li>③ When measurement range, unit, linear scale, alarm format etc is changed, sometimes the setting range and decimal point position changes automatically and relatively hence take care.</li> </ol>

<p>12. Alarm delay</p> <div style="border: 1px solid black; padding: 5px; width: fit-content; margin: 10px auto;"> ALARM ON DELAY  0 0 0 0.0 s </div>	<ol style="list-style-type: none"> <li>① Set the alarm delay time.</li> <li>② If judgment time of alarm ON is continuously equal to or more than the set value, the initial alarm becomes ON. If judgment time of alarm ON is less than the set value, alarm does not become ON.</li> <li>③ For all the four points of alarm there is a common setting value hence take care.</li> </ol>
<p>13.SV 8 types for AT2</p> <div style="border: 1px solid black; padding: 5px; width: fit-content; margin: 10px auto;"> AUTO TUNING 2  SV1 ON 0 0 0 0. 0 </div>	<ol style="list-style-type: none"> <li>① Set 8 types of SV for auto tuning AT@.</li> <li>② You can set auto tuning to ON (execute)/OFF (do not execute) for 8 types individually.</li> <li>③ Setting range is within the measurement scope (including linear scale).</li> <li>④ PID calculated in SV number 1 to 8 for AT2 is registered in PID numbers 1 to 8.</li> <li>⑤ When measurement range, unit, measurement scope, linear scale is changed, sometimes the setting range and decimal point position changes or initialization occurs automatically and relatively, hence take care.</li> </ol>
<p>14. SV section for automatic PID</p> <div style="border: 1px solid black; padding: 5px; width: fit-content; margin: 10px auto;"> SV SCOPE PID No. 9 - 1  - 0 2 0 0 . 0 ~ - 0 0 0 3 . 8 </div>	<ol style="list-style-type: none"> <li>① Set SV section 8 types for automatic PID conversion system.</li> <li>② Setting range is within the measurement scope (including linear scale).</li> <li>③ When measurement range, unit, measurement scope, linear scale is changed, the setting range and decimal point position sometimes changes or initialization occurs automatically and relatively, hence take care.</li> </ol>
<p>15. SV 8 types for AT3</p> <div style="border: 1px solid black; padding: 5px; width: fit-content; margin: 10px auto;"> AUTO TUNING 3  SV1 OFF - 0 1 0 1 . 9 </div>	<ol style="list-style-type: none"> <li>① Set 8 types of SV for auto tuning AT3.</li> <li>② You can set auto tuning to ON (Execute)/OFF (do not execute) for 8 types individually.</li> <li>③ Setting range is within the scope of SV section of corresponding automatic PID switching system.</li> <li>④ PID calculated using SV numbers 1 to 8 for AT3, is registered in PID numbers from 9-1 to 9-8.</li> <li>⑤ When measurement range, unit, measurement scope, linear scale is changed, sometimes setting range and decimal point position sometimes changes or initialization occurs automatically and relatively, hence take care.</li> </ol>
<p>16. AT2, AT3 start direction</p> <div style="border: 1px solid black; padding: 5px; width: fit-content; margin: 10px auto;"> AT2/AT3 START  UP DOWN </div>	<ol style="list-style-type: none"> <li>① Set the direction of execution at the time of executing auto tuning AT2 or AT3.</li> <li>② When 'UP' is selected, auto tuning moves from SV1 to SV8.</li> <li>③ When 'DOWN' is selected, auto tuning moves from SV8 to SV1.</li> </ol>
<p>17.Control algorithm</p> <div style="border: 1px solid black; padding: 5px; width: fit-content; margin: 10px auto;"> PID TYPE  POSITION/VELOCITY </div>	<ol style="list-style-type: none"> <li>① Set control algorithm.</li> <li>② If 'POSITION' is selected, it is position type PID system.</li> <li>③ If 'VELOCITY' is selected, it is velocity type PID system.</li> </ol>

## 7-6. Mode 4

Mode 4 performs the setting related output.



Settings screen	Description of the screen
<p>1. Mode screen</p> <div style="border: 1px solid black; padding: 5px; width: fit-content; margin: 5px 0;">           MODE 4 OUTPUT SET         </div> <p>[Lock Status]</p> <div style="border: 1px solid black; padding: 5px; width: fit-content; margin: 5px 0;">           MODE 4 Lock OUTPUT SET         </div> <p>[Display OFF status]</p> <div style="border: 1px solid black; padding: 5px; width: fit-content; margin: 5px 0;">           MODE 4 NoDisp OUTPUT SET         </div>	<p>① Mode 4 screen</p> <p>② By clicking the   key, 'Lock' and 'No Disp' is displayed.</p> <p>③ For mode 4 settings screen, if setting change is to be prohibited select 'Lock'.</p> <p>④ When doing the settings by communications, set all the mode screens to 'Lock'.</p> <p>⑤ When settings screen of mode 4 is not displayed, select 'NoDisp'.</p>
<p>2. Output limiter 8 types</p> <div style="border: 1px solid black; padding: 5px; width: fit-content; margin: 5px 0;">           OUTPUT LIMIT No. 1 L: 000.0% H: 100.0%         </div> <p>[Output scale specifications]</p> <div style="border: 1px solid black; padding: 5px; width: fit-content; margin: 5px 0;">           OUTPUT SCALE No. 1 L: 000.0% H: 100.0%         </div> <p>※ Option</p>	<p>① Set 8 types of output limiters.</p> <p>② Set lower limit of output limiter in 'L' , and upper limit of output limiter in 'H'.</p> <p>③ In either of automatic output operation and manual output operation the output is within this setting range.</p> <p>④ In case of output scale specifications (option) instead of output limiter, the screen is as shown on the lower left.</p> <p>⑤ After the settings, it is necessary to set the output limiter number that is to be used for each pattern/step in mode 2.</p>
<p>3. Output 2 limiter</p> <div style="border: 1px solid black; padding: 5px; width: fit-content; margin: 5px 0;">           OUT2 OUTPUT LIMIT L: 000.0% H: 100.0%         </div> <p>[Output scale specifications]</p> <div style="border: 1px solid black; padding: 5px; width: fit-content; margin: 5px 0;">           OUT2 OUTPUT SCALE L: 000.0% H: 100.0%         </div> <p>※ Option</p>	<p>① It is displayed in case of output 2 specifications only.</p> <p>② Set the output limiter of output 2 side.</p> <p>③ Set lower limit of output limiter in 'L' , and upper limit of output limiter in 'H'.</p> <p>④ In either of automatic output operation and manual output operation the output is within this setting range.</p> <p>⑤ In case of output scale specifications (option) instead of output limiter specifications, the screen is as shown on the lower left.</p>
<p>4. Output variation limiter 8 types</p> <div style="border: 1px solid black; padding: 5px; width: fit-content; margin: 5px 0;">           OSL UP/DOWN No. 1 100.0% / -100.0%         </div>	<p>① Set 8 types of output variation limiters.</p> <p>② On the lower left, output variation limiter at the time of ascending output and on the lower right, output variation limiter at the time of descending output are displayed.</p> <p>③ After the settings, it is necessary to set the output variation limiter number that is to be used for each pattern/step in mode 2.</p>

<p>5. Output 2 variation limiter</p> <div style="border: 1px solid black; padding: 5px; width: fit-content; margin: 10px auto;">       OUT2 OSL UP/DOWN        100.0% / -100.0%     </div>	<ul style="list-style-type: none"> <li>① It is displayed only in case of output 2 specifications.</li> <li>② Set output variation limiter of output 2 side.</li> <li>③ On the lower left, output variation limiter at the time of ascending output and on the lower right, output variation limiter at the time of descending output are displayed.</li> </ul>
<p>6. At the time of exiting the program</p> <div style="border: 1px solid black; padding: 5px; width: fit-content; margin: 10px auto;">       PROGRAM END OUT        PTN:01 CONTROL     </div> <p>[Output 2 specifications]</p> <div style="border: 1px solid black; padding: 5px; width: fit-content; margin: 10px auto;">       END OUT1/2 PTN:01        000.0% / 000.0%     </div>	<ul style="list-style-type: none"> <li>① Set the output value (MV) at the time of ending the program (END).</li> <li>② If 'CONTROL' is selected, continue the automatic output operation (or manual output operation) by using final SV, until it is reset.</li> <li>③ If output value is set directly, continue with that output value until resetting (RESET) is done.</li> <li>④ Output range is within the output limiter range.</li> <li>⑤ Set it for each pattern number.</li> </ul>
<p>7. Output preset</p> <div style="border: 1px solid black; padding: 5px; width: fit-content; margin: 10px auto;">       OUTPUT PRESET        050.0%     </div>	<ul style="list-style-type: none"> <li>① Set output preset.</li> <li>② Output range is within the output limiter range.</li> </ul>
<p>8. Pulse cycle</p> <div style="border: 1px solid black; padding: 5px; width: fit-content; margin: 10px auto;">       PULSE CYCLE        030s     </div> <p>[Output 2 specifications]</p> <div style="border: 1px solid black; padding: 5px; width: fit-content; margin: 10px auto;">       PULSE CYCLE OUT1/2        030s/030s     </div>	<ul style="list-style-type: none"> <li>① Output type displays only ON-OFF pulse type or SSR drive pulse type.</li> <li>② Set time for one cycle of output ON/OFF.</li> <li>③ In output 2 specifications, do the respective settings in case of output 2 and pulse type.</li> <li>④ When setting value is changed, after end of one cycle before the setting value that is changed, do the operation using the setting value after the changed settings.</li> <li>⑤ Generally set the highest value as far as possible that is within the range and that does not adversely affect the controllability.</li> </ul>
<p>9. FB tuning</p> <div style="border: 1px solid black; padding: 5px; width: fit-content; margin: 10px auto;">       F. B. AUTO TUNING        END START     </div>	<ul style="list-style-type: none"> <li>① Output format displays only ON-OFF servo type.</li> <li>② This function is a function that automatically requests the setting value of FB zero span of this controller and the actuator (motor etc.)</li> <li>③ When FB tuning is started, AT progress status (START, CLOSE, TUNE-ZERO, OPEN, TUNE-SPAN) is displayed.</li> <li>④ If you want to stop FB tuning in between, set 'END'.</li> <li>⑤ FB zero span requested in FB tuning, can be confirmed by 'FB zero span' of mode 4.</li> </ul>
<p>10. FB zero span</p> <div style="border: 1px solid black; padding: 5px; width: fit-content; margin: 10px auto;">       F. B. ZERO/SPAN        Z:00.0% S:100.0%     </div>	<ul style="list-style-type: none"> <li>① Output type displays ON-OFF servo type only.</li> <li>② Set the FB zero span of this controller and actuator (motor etc.).</li> <li>③ Set zero value in 'Z' and span value in 'S'.</li> </ul>

<p>11.FB dead band</p> <div style="border: 1px solid black; padding: 5px; width: fit-content; margin: 10px auto;"> <p>F . B .            D . B A N D                           1 . 0 %</p> </div>	<ul style="list-style-type: none"> <li>① Output format displays ON-OFF servo type only.</li> <li>② Set FB gain (dead band).</li> <li>③ Generally, set a value as large as possible and within the scope such that it does not adversely affect the controllability. This setting value is not an accurate percentage (%) value, hence as far as possible take it as a reference.</li> </ul>
<p>12. Output at the time of PV abnormality</p> <div style="border: 1px solid black; padding: 5px; width: fit-content; margin: 10px auto;"> <p>P V   E R R   O V R : 0 0 0 . 0 % O U T    U D R : 0 0 0 . 0 %</p> </div>	<ul style="list-style-type: none"> <li>① Output value at the time of PV abnormality is set.</li> <li>② Set respectively the output value in 'OVR' when PV exceeds the range (including higher limit burnout) and set the value in 'UDR' when PV is below the range (including lower limit burnout).</li> <li>③ Output range is within the output limiter range.</li> </ul>
<p>13. Output at the time of output 2 PV abnormality</p> <div style="border: 1px solid black; padding: 5px; width: fit-content; margin: 10px auto;"> <p>P V   E R R   O V R : 0 0 0 . 0 % O U T 2   U D R : 0 0 0 . 0 %</p> </div>	<ul style="list-style-type: none"> <li>① It is displayed only in case of output 2 specifications.</li> <li>② Set the output value at the time of PV abnormality of output 2 side.</li> <li>③ Set respectively the output value in 'OVR' when PV exceeds the range (including higher limit burnout) and set the value in 'UDR' when PV is below the range (including lower limit burnout).</li> <li>④ Output range is within the range of output 2 limiter.</li> </ul>
<p>14. Direct/Reverse control operation</p> <div style="border: 1px solid black; padding: 5px; width: fit-content; margin: 10px auto;"> <p>O U T P U T   M O D E D I R E C T    R E V E R S E</p> </div> <p>[Output 2 specifications]</p> <div style="border: 1px solid black; padding: 5px; width: fit-content; margin: 10px auto;"> <p>O U T P U T   M O D E   O U T 1 / 2 R E V E R S E   /   D I R E C T</p> </div>	<ul style="list-style-type: none"> <li>① Set control operation.</li> <li>② If 'DIRECT' is selected, it becomes a direct operation (Cooling operation).</li> <li>③ If 'REVERSE' is selected, it becomes a reverse operation (heating operation).</li> <li>④ In case of output 2 specifications, display the screen shown on the lower left and set control operation of output 1 on the left side of the [/] and output 2 on the right side of each.</li> </ul>

## 7-7. Mode 5

Mode 5 performs the setting related input.

Settings screen	Description of the screen																																																																																																																																																																	
<p>1.Mode screen</p> <div style="border: 1px solid black; padding: 5px; text-align: center;">           MODE 5 INPUT SET         </div> <p>[Lock Status]</p> <div style="border: 1px solid black; padding: 5px; text-align: center;">           MODE 5 Lock INPUT SET         </div> <p>[Display OFF status]</p> <div style="border: 1px solid black; padding: 5px; text-align: center;">           MODE 5 NoDisp INPUT SET         </div>	<p>① Mode 5 screen.</p> <p>② By clicking the  ·  key, 'Lock' and 'NoDisp' is displayed.</p> <p>③ For mode 5 settings screen, if setting change is to be prohibited select 'Lock'.</p> <p>④ When doing the settings by communications, set all the mode screens to 'Lock'.</p> <p>⑤ When settings screen of mode 5 is not displayed, select 'NoDisp'.</p>																																																																																																																																																																	
<p>2. Measurement range</p> <div style="border: 1px solid black; padding: 5px; text-align: center;">           INPUT KIND 0 5 K 1         </div>	<p>① Set the measurement range.</p> <p>② Types of measurement ranges are as shown in the table below.</p> <p>③ It differs depending on the measurement range, however it exceeds the upper limit of the scale range by approximately +5% and is below the range by approximately -5%.</p> <p>④ When measurement range is changed, sometimes setting range and decimal point position changes or initialization occurs automatically and relatively hence take care.</p>																																																																																																																																																																	
[Universal]																																																																																																																																																																		
<table border="1"> <thead> <tr> <th>No.</th> <th>Measurement range</th> <th>Scale range (°C)</th> <th>No.</th> <th>Measurement range</th> <th>Scale range (°C)</th> <th>No.</th> <th>Measurement range</th> <th>Scale range (°C)</th> </tr> </thead> <tbody> <tr> <td>01</td> <td rowspan="17">Thermocouple</td> <td>B</td> <td>0.0 to 1820.0</td> <td>18</td> <td rowspan="10">Thermocouple</td> <td>WRe5-26</td> <td>0.0 to 2310.0</td> <td rowspan="3">36</td> <td rowspan="3">Direct current (Linear)</td> <td rowspan="3">20mA</td> <td rowspan="3">0 to 20mA</td> </tr> <tr> <td>02</td> <td>R1</td> <td>0.0 to 1760.0</td> <td>19</td> <td>W-WRe26</td> <td>0.0 to 2310.0</td> </tr> <tr> <td>03</td> <td>R2</td> <td>0.0 to 1200.0</td> <td>20</td> <td>NiMo-Ni</td> <td>-50.0 to 1410.0</td> </tr> <tr> <td>04</td> <td>S</td> <td>0.0 to 1760.0</td> <td>21</td> <td>CR-AuFe</td> <td>0.0 to 280.0 K</td> <td rowspan="7">41</td> <td rowspan="17">Resistance thermometer</td> <td>JPt100Ω1</td> <td>-200.0 to 649.0</td> </tr> <tr> <td>05</td> <td>K1</td> <td>-200.0 to 1370.0</td> <td>22</td> <td>N</td> <td>0.0 to 1300.0</td> <td>42</td> <td>JPt100Ω2</td> <td>-200.0 to 400.0</td> </tr> <tr> <td>06</td> <td>K2</td> <td>0.0 to 600.0</td> <td>23</td> <td>PR5-20</td> <td>0.0 to 1800.0</td> <td>44</td> <td>JPt100Ω4</td> <td>-200.0 to 200.0</td> </tr> <tr> <td>07</td> <td>K3</td> <td>-200.0 to 300.0</td> <td>24</td> <td>PtRh40-20</td> <td>0.0 to 1880.0</td> <td>45</td> <td>JPt100Ω5</td> <td>-100.0 to 100.0</td> </tr> <tr> <td>08</td> <td>E1</td> <td>-270.0 to 1000.0</td> <td>25</td> <td>Plati II 1</td> <td>0.0 to 1390.0</td> <td>46</td> <td>QPt100Ω1</td> <td>-200.0 to 649.0</td> </tr> <tr> <td>09</td> <td>E2</td> <td>0.0 to 700.0</td> <td>26</td> <td>Plati II 2</td> <td>0.0 to 600.0</td> <td>47</td> <td>QPt100Ω2</td> <td>-200.0 to 400.0</td> </tr> <tr> <td>10</td> <td>E3</td> <td>-270.0 to 300.0</td> <td>27</td> <td>U</td> <td>-200.0 to 400.0</td> <td>49</td> <td>QPt100Ω4</td> <td>-200.0 to 200.0</td> </tr> <tr> <td>11</td> <td>E4</td> <td>-270.0 to 150.0</td> <td>28</td> <td>L</td> <td>-200.0 to 900.0</td> <td>50</td> <td>QPt100Ω5</td> <td>-100.0 to 100.0</td> </tr> <tr> <td>12</td> <td>J1</td> <td>-200.0 to 1200.0</td> <td>31</td> <td rowspan="7">DC voltage (Linear)</td> <td>10mV</td> <td>±10mV</td> <td>51</td> <td>JPt50Ω</td> <td>-200.0 to 649.0</td> </tr> <tr> <td>13</td> <td>J2</td> <td>-200.0 to 900.0</td> <td>32</td> <td>20mV</td> <td>±20mV</td> <td>53</td> <td>Pt100Ω1</td> <td>-200.0 to 850.0</td> </tr> <tr> <td>14</td> <td>J3</td> <td>-200.0 to 400.0</td> <td>33</td> <td>50mV</td> <td>±50mV</td> <td>54</td> <td>Pt100Ω2</td> <td>-200.0 to 400.0</td> </tr> <tr> <td>15</td> <td>J4</td> <td>-100.0 to 200.0</td> <td>34</td> <td>100mV</td> <td>±100mV</td> <td>56</td> <td>Pt100Ω4</td> <td>-200.0 to 200.0</td> </tr> <tr> <td>16</td> <td>T1</td> <td>-270.0 to 400.0</td> <td>35</td> <td>5V</td> <td>±5V</td> <td>57</td> <td>Pt100Ω5</td> <td>-100.0 to 100.0</td> </tr> <tr> <td>17</td> <td>T2</td> <td>-200.0 to 200.0</td> <td>37</td> <td>10V</td> <td>±10V</td> <td></td> <td></td> <td></td> </tr> </tbody> </table>		No.	Measurement range	Scale range (°C)	No.	Measurement range	Scale range (°C)	No.	Measurement range	Scale range (°C)	01	Thermocouple	B	0.0 to 1820.0	18	Thermocouple	WRe5-26	0.0 to 2310.0	36	Direct current (Linear)	20mA	0 to 20mA	02	R1	0.0 to 1760.0	19	W-WRe26	0.0 to 2310.0	03	R2	0.0 to 1200.0	20	NiMo-Ni	-50.0 to 1410.0	04	S	0.0 to 1760.0	21	CR-AuFe	0.0 to 280.0 K	41	Resistance thermometer	JPt100Ω1	-200.0 to 649.0	05	K1	-200.0 to 1370.0	22	N	0.0 to 1300.0	42	JPt100Ω2	-200.0 to 400.0	06	K2	0.0 to 600.0	23	PR5-20	0.0 to 1800.0	44	JPt100Ω4	-200.0 to 200.0	07	K3	-200.0 to 300.0	24	PtRh40-20	0.0 to 1880.0	45	JPt100Ω5	-100.0 to 100.0	08	E1	-270.0 to 1000.0	25	Plati II 1	0.0 to 1390.0	46	QPt100Ω1	-200.0 to 649.0	09	E2	0.0 to 700.0	26	Plati II 2	0.0 to 600.0	47	QPt100Ω2	-200.0 to 400.0	10	E3	-270.0 to 300.0	27	U	-200.0 to 400.0	49	QPt100Ω4	-200.0 to 200.0	11	E4	-270.0 to 150.0	28	L	-200.0 to 900.0	50	QPt100Ω5	-100.0 to 100.0	12	J1	-200.0 to 1200.0	31	DC voltage (Linear)	10mV	±10mV	51	JPt50Ω	-200.0 to 649.0	13	J2	-200.0 to 900.0	32	20mV	±20mV	53	Pt100Ω1	-200.0 to 850.0	14	J3	-200.0 to 400.0	33	50mV	±50mV	54	Pt100Ω2	-200.0 to 400.0	15	J4	-100.0 to 200.0	34	100mV	±100mV	56	Pt100Ω4	-200.0 to 200.0	16	T1	-270.0 to 400.0	35	5V	±5V	57	Pt100Ω5	-100.0 to 100.0	17	T2	-200.0 to 200.0	37	10V	±10V			
No.	Measurement range	Scale range (°C)	No.	Measurement range	Scale range (°C)	No.	Measurement range	Scale range (°C)																																																																																																																																																										
01	Thermocouple	B	0.0 to 1820.0	18	Thermocouple	WRe5-26	0.0 to 2310.0	36	Direct current (Linear)	20mA	0 to 20mA																																																																																																																																																							
02		R1	0.0 to 1760.0	19		W-WRe26	0.0 to 2310.0																																																																																																																																																											
03		R2	0.0 to 1200.0	20		NiMo-Ni	-50.0 to 1410.0																																																																																																																																																											
04		S	0.0 to 1760.0	21		CR-AuFe	0.0 to 280.0 K	41	Resistance thermometer	JPt100Ω1	-200.0 to 649.0																																																																																																																																																							
05		K1	-200.0 to 1370.0	22		N	0.0 to 1300.0			42	JPt100Ω2		-200.0 to 400.0																																																																																																																																																					
06		K2	0.0 to 600.0	23		PR5-20	0.0 to 1800.0			44	JPt100Ω4		-200.0 to 200.0																																																																																																																																																					
07		K3	-200.0 to 300.0	24		PtRh40-20	0.0 to 1880.0			45	JPt100Ω5		-100.0 to 100.0																																																																																																																																																					
08		E1	-270.0 to 1000.0	25		Plati II 1	0.0 to 1390.0			46	QPt100Ω1		-200.0 to 649.0																																																																																																																																																					
09		E2	0.0 to 700.0	26		Plati II 2	0.0 to 600.0			47	QPt100Ω2		-200.0 to 400.0																																																																																																																																																					
10		E3	-270.0 to 300.0	27		U	-200.0 to 400.0			49	QPt100Ω4		-200.0 to 200.0																																																																																																																																																					
11		E4	-270.0 to 150.0	28	L	-200.0 to 900.0	50	QPt100Ω5		-100.0 to 100.0																																																																																																																																																								
12		J1	-200.0 to 1200.0	31	DC voltage (Linear)	10mV	±10mV	51		JPt50Ω	-200.0 to 649.0																																																																																																																																																							
13		J2	-200.0 to 900.0	32		20mV	±20mV	53		Pt100Ω1	-200.0 to 850.0																																																																																																																																																							
14		J3	-200.0 to 400.0	33		50mV	±50mV	54		Pt100Ω2	-200.0 to 400.0																																																																																																																																																							
15		J4	-100.0 to 200.0	34		100mV	±100mV	56		Pt100Ω4	-200.0 to 200.0																																																																																																																																																							
16		T1	-270.0 to 400.0	35		5V	±5V	57		Pt100Ω5	-100.0 to 100.0																																																																																																																																																							
17		T2	-200.0 to 200.0	37		10V	±10V																																																																																																																																																											

[4-wire resistance thermometer]

No.	Measurement range	Scale range (°C)	No.	Measurement range	Scale range (°C)	No.	Measurement range	Scale range (°C)
41	JPt100Ω1	-200.0 to 649.0	47	QPt100Ω2	-200.0 to 400.0	53	Pt100Ω1	-200.0 to 850.0
42	JPt100Ω2	-200.0 to 400.0	49	QPt100Ω4	-200.0 to 200.0	54	Pt100Ω2	-200.0 to 400.0
44	JPt100Ω4	-200.0 to 200.0	50	QPt100Ω5	-100.0 to 100.0	56	Pt100Ω4	-200.0 to 200.0
45	JPt100Ω5	-100.0 to 100.0	51	JPt50Ω	-200.0 to 649.0	57	Pt100Ω5	-100.0 to 100.0
46	QPt100Ω1	-200.0 to 649.0	52	Pt-Co	4.0 to 374.0 K			

3.RJ

```
R J  C A L C U L A T I O N
I N T      E X T
```

- ① This is displayed when select [thermocouple] of measurement range.
- ② When 'INT' is selected RJ functionality is switched ON. Usually 'INT' is selected.
- ③ When 'EXT' is selected RJ functionality is switched OFF.

4.Unit

```
M E A S U R E   U N I T
° C      K
```

- ① Select the unit when measurement range is [thermocouple] or [resistance thermometer].
- ② When measurement range is 'CR-AuFe' or 'Pt-Co' unit is 'K', unit is [K] only not selected [°C].
- ③ When unit is changed, sometimes setting range and decimal point position changes or initialization occurs automatically and relatively hence take care.

5.Measurement scope

```
R A N G E   S E T
- 0 2 0 0 . 0 ~ 1 3 7 0 . 0
```

[Linear scale]

```
R A N G E   S E T
0 0 . 0 0 0 ~ 1 0 . 0 0 0
```

- ① Set the measurement scope to be actually used for the scale range of measurement range.
- ② The meaning of thermocouple and resistance thermometer is as follows.
  - P in PID calculation is equivalent to 100%.
  - It becomes the maximum setting range like SV range etc.
- ③ In case of linear input, meaning of measurement scope is as follows.
  - It becomes the reference range which is the base of linear scale (with scale.)
- ④ Setting range is within the scale range of the measurement range that is selected.
- ⑤ When measurement scope is changed, sometimes setting range and decimal point position changes or initialization occurs automatically and relatively hence take care.

6. Linear scale

```
L I N E A R   S C A L E   D O T 1
0 0 0 0 . 0 ~ 2 0 0 0 . 0
```



- ① Measurement range is displayed only when 'Linear scale' is selected.
- ② Set scale (with scale) for reference range that is set in measurement scope. P in PID calculation is equivalent to 100%.
- ③ Set decimal point position in 'DOT', lower limit value (0%) on the lower left on the scale and higher limit value (100%) on the lower right of the scale.
- ④ When linear scale is changed, sometimes setting range and decimal point position changes or initialization occurs automatically and relatively hence take care.

<p>7. Sensor correction 8 types</p> <div style="border: 1px solid black; padding: 5px; width: fit-content; margin: 10px auto;"> <p style="text-align: center;">INPUT SHIFT</p> <p style="text-align: center;">NO. 1      000.00</p> </div>	<ol style="list-style-type: none"> <li>① Set 8 types of sensor corrections (PV bias).</li> <li>② After the settings, it is necessary to set the sensor correction that is to be used for each pattern/step in mode 2.</li> <li>③ When measurement range, unit, measurement scope, linear scale etc is changed, sometimes the setting range and decimal point position changes automatically and relatively, hence take care.</li> </ol>
<p>8. PV decimal point</p> <div style="border: 1px solid black; padding: 5px; width: fit-content; margin: 10px auto;"> <p style="text-align: center;">PV DISPLAY DOT</p> <p style="text-align: center;">1</p> </div>	<ol style="list-style-type: none"> <li>① Set the decimal point position of PV.</li> <li>② Based on the decimal point position that is set, up to five digits including the integer part are displayed. Hence only if the number of digits of integer is less, more number of digits after the decimal point can be displayed within the range of decimal point position that is set.</li> <li>③ When measurement range, unit, linear scale etc is changed, sometimes setting range and decimal point position changes automatically and relatively hence take care.</li> </ol>
<p>9. Digital filter</p> <div style="border: 1px solid black; padding: 5px; width: fit-content; margin: 10px auto;"> <p style="text-align: center;">PV FILTER</p> <p style="text-align: center;">00.1 s</p> </div>	<ol style="list-style-type: none"> <li>① Do the first-order lag operation in PV. It is a valid function when flat key in PV that is being executed is big.</li> </ol>
<p>10. SV decimal point for display</p> <div style="border: 1px solid black; padding: 5px; width: fit-content; margin: 10px auto;"> <p style="text-align: center;">SV DISPLAY DOT</p> <p style="text-align: center;">1</p> </div>	<ol style="list-style-type: none"> <li>① Set the SV decimal point displayed at upper display.</li> <li>② Maximum 5 digits include integer are displayed based on set decimal position. When digits of integer number is small, possible to display more digits after the decimal point within the range of position of decimal point.</li> <li>③ When measurement range, unit, linear scale etc is changed, sometimes setting range and decimal point position changes automatically and relatively hence take care.</li> </ol>



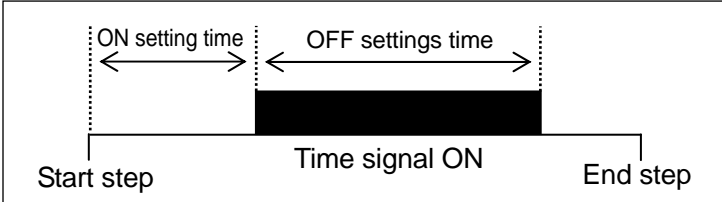

## 7-8. Mode 6

Mode 6 performs the setting of time bent.

Settings screen	Description of the screen
<p>1. Mode screen</p> <div style="border: 1px solid black; padding: 5px; margin-bottom: 10px;">           MODE 6 TIME EVENT         </div> <p>[Lock status]</p> <div style="border: 1px solid black; padding: 5px; margin-bottom: 10px;">           MODE 6 Lock TIME EVENT         </div> <p>[Display OFF status]</p> <div style="border: 1px solid black; padding: 5px;">           MODE 6 NoDisp TIME EVENT         </div>	<p>① Mode 6 screen.</p> <p>② By clicking the  ·  key, 'Lock' and 'NoDisp' is displayed.</p> <p>③ For mode 6 settings screen, if setting change is to be prohibited select 'Lock'.</p> <p>④ When doing the settings by communications, set all the mode screens to 'Lock'.</p> <p>⑤ When settings screen of mode 6 is not displayed, select 'NoDisp'.</p>
<p>2. Time signal 8 types</p> <div style="border: 1px solid black; padding: 5px; margin-top: 10px;">           TIME SIG ON000:00 No. 1 OFF001:00         </div>	<p>① This is displayed only for time signal specification.</p> <p>② Set 8 types of time signal.</p> <p>③ Set time from the time of starting the step to switching the time signal ON in 'ON', and set the time from the time of switching the time signal ON to switching it OFF in 'OFF'.</p> <div style="border: 1px solid black; padding: 10px; margin: 10px 0;">  </div> <p>④ Set the unit in 'time unit' of mode 2.</p> <p>⑤ After the settings, it is necessary to set the time signal number that is to be used for each pattern/step in mode 2.</p>
<p>3. Real temperature compensation 8 types</p> <div style="border: 1px solid black; padding: 5px; margin-top: 10px;">           GUARANTY SOAK No. 1 2000.0         </div>	<p>① Set 8 types of real temperature compensations.</p> <p>② After the settings, it is necessary to set real temperature compensation number that is to be used for each pattern/step in mode 2.</p> <p>③ When measurement range, unit, measurement scope, linear scale etc is changed, sometimes the setting range and decimal point position changes automatically and relatively, hence take care.</p>
<p>4. Waiting time alarm 8 types</p> <div style="border: 1px solid black; padding: 5px; margin-top: 10px;">           WAIT TIMER No. 1 001:00         </div>	<p>① Set 8 types of waiting time alarms.</p> <p>② Unit is the unit set in 'time unit' of mode 2.</p> <p>③ After the settings, it is necessary to set the waiting time alarm number that is to be used for each pattern/step in mode 2.</p>



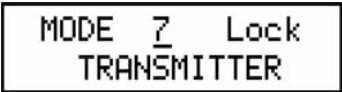
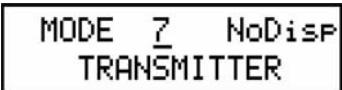

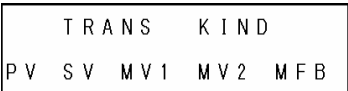
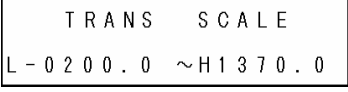



## 7-9. Mode 7

Mode 7 performs the setting of transmission signal output.

Settings screen	Description of the screen
<p>1. Mode screen</p>  <p>[Lock Status]</p>  <p>[Display OFF status]</p> 	<ul style="list-style-type: none"> <li>① Mode 7 screen. Only the specifications with transmission signal output are displayed.</li> <li>② By clicking the  ·  key, 'Lock' and 'No Disp' is displayed.</li> <li>③ For mode 7 settings screen, if setting change is to be prohibited select 'Lock'.</li> <li>④ When doing the settings by communications, set all the mode screens to 'Lock'.</li> <li>⑤ When settings screen of mode 7 is not displayed, select 'NoDisp'.</li> </ul>
<p>2. Transmission types</p> 	<ul style="list-style-type: none"> <li>① Display only the specifications with transmission signal output.</li> <li>② When 'PV' is selected, measurement value (PV) is transmitted.</li> <li>③ When 'SV' is selected, measurement value (SV) is transmitted.</li> <li>④ When 'MV' is selected, output value (MV) is selected.</li> <li>⑤ When 'MFB' is selected, actuator feedback value (MFB) is transmitted, but ON-OFF servo type only.</li> <li>⑥ In case of output 2 specifications, output 1 side 'MV1' and output 2 side 'MV2' can be selected.</li> <li>⑦ When transmission type is changed sometimes setting range and decimal point position changes or it may be initialized automatically and relatively hence take care.</li> </ul>
<p>3. Transmission scale</p> 	<ul style="list-style-type: none"> <li>① Specifications with transmission signal output only are displayed.</li> <li>② Set a scale corresponding to transmission signal output (analog signal) of high accuracy type.</li> <li>③ Set lower limit (0%) and higher limit (100%) of the scale for the minimum value (0%) and maximum value (100%) of the transmission signal output.</li> <li>④ When transmission scale is changed, sometimes setting range and decimal point position changes automatically and relatively hence take care.</li> </ul>

## 7-10. Mode 8

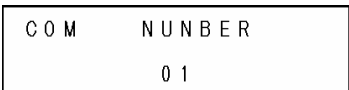

Mode 8 performs the setting related to communications.

Settings screen	Description of the screen
<p>1.Mode screen</p>  <p>[Lock Status]</p>  <p>[Display OFF status]</p> 	<p>① Mode 8 screen. Only the instrument with communications is displayed.</p> <p>② By clicking the  ·  key, 'Lock' and 'NoDisp' is displayed.</p> <p>③ For mode 8 settings screen, if setting change is to be prohibited select 'Lock'.</p> <p>④ When doing the settings by communications, set all the mode screens to 'Lock'.</p> <p>⑤ When settings screen of mode 8 is not displayed, select 'NoDisp'.</p>
<p>2. Communication speed</p> 	<p>① Only the instrument with communications is displayed.</p> <p>② Set the communications speed.</p>
<p>3. Instrument number</p> 	<p>① Only the instrument with communications is displayed.</p> <p>② Set the instrument number.</p>
<p>4. Communications function</p> 	<p>① Only the instrument with communications is displayed.</p> <p>② Set the communications function.</p> <p>③ If 'COM' is selected it is higher order communications function.</p> <p>④ If 'TRANS' is selected, it is communications transmission function.</p>
<p>5. Communication transmission types</p> 	<p>① It only displays with the instrument with communications, and when 'TRANS' is selected.</p> <p>② Set the communications transmission type.</p> <p>③ When 'PV' is selected, measurement value (PV) is transmitted.</p> <p>④ When 'SV' is selected, setting value (SV) is transmitted.</p> <p>⑤ When 'MV' is selected, output value (MV) is transmitted.</p> <p>⑥ When 'MFB' is selected, actuator feedback value (MFB) is transmitted, but ON-OFF servo type only.</p> <p>⑧ In case of output 2 specifications, you can select separately output 1 side 'MV1' and output 2 side 'MV2'.</p>

<p>6. Communications protocol</p> <div style="border: 1px solid black; padding: 5px; width: fit-content; margin: 10px auto;"> COM      P R O T O C O L  MODBUS ( R T U ) </div>	<ol style="list-style-type: none"> <li>① Only the instrument with communications is displayed.</li> <li>② Set communications protocol.</li> <li>③ If 'MODBUS (RTU)' is selected, MODBUS (RTU) is displayed.</li> <li>④ If 'MODBUS (ASCII)' is selected, MODBUS (ASCII) is displayed.</li> <li>⑤ If 'PRIVATE' is selected, CHINO protocol is displayed.</li> </ol>
<p>7. Communications character</p> <div style="border: 1px solid black; padding: 5px; width: fit-content; margin: 10px auto;"> COM      C H A R C T E R  8 B I T / N O N   / S T O P 1 </div>	<ol style="list-style-type: none"> <li>① It only displays with the instrument with communications, and when 'MODBUS' is selected.</li> <li>② Set communications character (bit length, parity, stop bit).</li> </ol>

## 7-11. Mode 11

Mode 11 performs the setting related to system (Initial settings).

Settings screen	Description of the screen
<p>1. Mode screen</p> <div style="border: 1px solid black; padding: 5px; width: fit-content; margin: 10px auto;"> MODE 11  SYSTEM 1 </div> <p>[Lock Status]</p> <div style="border: 1px solid black; padding: 5px; width: fit-content; margin: 10px auto;"> MODE 11    Lock  SYSTEM 1 </div> <p>[Display OFF status]</p> <div style="border: 1px solid black; padding: 5px; width: fit-content; margin: 10px auto;"> MODE 11    NoDisp  SYSTEM 1 </div>	<ol style="list-style-type: none"> <li>① Mode 11 screen.</li> <li>② By clicking the   key, 'Lock' and 'No Disp' is displayed.</li> <li>③ For mode 11 settings screen, if setting change is to be prohibited select 'Lock'.</li> <li>④ When doing the settings by communications, set all the mode screens to 'Lock'.</li> <li>⑤ When settings screen of mode 11 is not displayed, select 'NoDisp'.</li> </ol>
<p>2. Display back light</p> <div style="border: 1px solid black; padding: 5px; width: fit-content; margin: 10px auto;"> D I S P L A Y   B A C K   L I G H T  G R E E N   O R A N G E   A U T O </div>	<ol style="list-style-type: none"> <li>① Set the back light color of lower window display.</li> <li>② If 'GREEN' is selected, usually green color is displayed.</li> <li>③ If 'ORANGE' is selected, usually orange color is displayed.</li> <li>④ If 'AUTO' is selected, usually green color is displayed however under the following conditions, orange color is displayed. <ul style="list-style-type: none"> <li>• When any of the alarms is activated.</li> <li>• When an error message is displayed.</li> </ul> By using this function effectively, alarm on/off can be judged at a glance. </li> </ol>

<p>3. Display contrast</p> <div style="border: 1px solid black; padding: 5px; text-align: center;">       DISPLAY VIEW ANGLE        0 5 0 %     </div>	<ol style="list-style-type: none"> <li>① It adjusts the contrast of LCD (Liquid crystal display) of lower display window.</li> <li>② Adjust and set the LCD such that the characters are clearly visible. 40 to 70% of range is suitable setting value. When set the range over or under, stripes appear in the LCD. Do not change the setting (initial value 50%) in ordinary use.</li> <li>③ Contrast is especially affected by the surrounding temperature hence do this adjustment approximately one hour after switching on the power supply and after the surrounding temperature becomes stable.</li> </ol>
<p>4. Key back light</p> <div style="border: 1px solid black; padding: 5px; text-align: center;">       KEY BACK LIGHT        AUTO OFF ON     </div>	<ol style="list-style-type: none"> <li>① It sets the lighting/switch off function of key backlight.</li> <li>② If 'AUTO' is selected, the following operation takes place.           <ul style="list-style-type: none"> <li>• Usually it is switched OFF, however when power is supplied or if any of the key is pressed, it illuminates and gets switched off if no key operation is done for approximately 30 seconds.</li> </ul> </li> <li>③ If 'OFF' is selected, it usually gets non-illuminated.</li> <li>④ If 'ON' is selected, it usually illuminates.</li> </ol>

## 7-12. Initializing the setup parameter

If set contents are to be returned to initial value, you can do it by the following procedure. There are two types of initializations and you can select from them. Once initialization is executed, you will not be able to return to the original setting contents hence take care.

Initialization type	Procedure	Screen that is being initialized
<p>1. Initializing the basic setting contents (Mode 0 to Mode 11)</p> <p>*Program pattern is not initialized.</p>	<ol style="list-style-type: none"> <li>① Cut off the power supply.</li> <li>② Switch on the power supply while pressing the <b>RUN/ MODE</b> key.</li> <li>③ After confirming that the screen shown on the right is displayed, release the <b>RUN/ MODE</b> key.</li> <li>④ After the initialization is done, operation screen is displayed.</li> </ol>	<div style="border: 1px solid black; padding: 10px; text-align: center;">       Parameter        Initialize     </div>
<p>2. Initializing all the setting contents (Mode 0 to Mode 11)</p> <p>* Program pattern is also initialized.</p>	<ol style="list-style-type: none"> <li>① Cut off the power supply.</li> <li>② Switch on the power supply while pressing the <b>RUN/ MODE</b> key and <b>A/M/ ENT</b> key.</li> <li>③ After confirming that the screen shown on the right is displayed, release the <b>RUN/ MODE</b> key and <b>A/M/ ENT</b> key.</li> <li>④ After the initialization is done, operation screen is displayed.</li> </ol>	<div style="border: 1px solid black; padding: 10px; text-align: center;">       All Parameter        Initialize     </div>

## 7-13. Precautions while setting

Precautions	Explanation
1. Precautions regarding the setting range.	<ul style="list-style-type: none"> <li>• In for numeric value settings parameter, there exists a range of numeric value that can be set, hence take care.</li> <li>• If you try to set a numeric value exceeding the numeric value range that can be set, an error message is displayed. When an error message is displayed confirm the contents of the error message and do the proper settings.</li> </ul>
2. When a setting is changed, sometimes the set contents of other settings change.	<ul style="list-style-type: none"> <li>• If the setting of important key parameters is changed, the decimal point position or the setting range of the set value of other related settings screen may sometimes change or may be initialized.</li> <li>• For example if 'measurement range', 'measurement scope', 'linear scale' of mode 5, 'alarm status' of mode 3, transmission type' of mode 7 etc. changed, the set contents of the other settings screen related to them will change.</li> <li>• If the settings of these key parameters is changed, reconfirm the set contents of other settings screen.</li> </ul>
3. When 'time 000:00' is to be set in program pattern.	<ul style="list-style-type: none"> <li>• When setting the program pattern in mode 2, for considering the SV of next step momentarily (by step), 'time 000:00' can be set. 'Time 000:00' can also be set in continuous steps however when a program pattern that has set 'time 000:00' for many continuous steps, as error may sometimes occur in the entire system without correct control operation being performed, hence do not do such settings.</li> <li>• In step 'time 000:00', only the operation of changing momentarily only the SV that is set is done. As a result, various calculation processes (PID, alarm, sensor correction etc.) for each step cannot be performed. However those setting contents are valid in 'time 000:00' step also. For example, set 'time 000:00' in step number 3 and set alarm number 4 in that step, in step number 4 which is the next step if alarm number 0 is set, the alarm of step number 04 starts operating by using alarm number 4.</li> <li>• In step 'time 000:00', real temperature compensation and time signal do not operate. If you want to operate those functions at least for a short time, set 'time 000:01' or more.</li> </ul>

## 7-14. Error message

### 7-14-1. Usual error display

If proper settings and operation is not done, following error messages are displayed for around 3 seconds. Confirm the contents of the error message and do the proper settings and operation again.

Error message	Error contents
1. <div style="border: 1px solid black; padding: 5px; width: fit-content; margin: 10px auto;">             ERROR                      No. 2 2              S V   R A N G E   O V E R           </div>	<ul style="list-style-type: none"> <li>• SV is exceeding the measurement range.</li> <li>• Confirm the measurement range and do the settings again.</li> </ul>
2. <div style="border: 1px solid black; padding: 5px; width: fit-content; margin: 10px auto;">             ERROR                      No. 5 6              P A T T E R N   I S   R U N N I N G           </div>	<ul style="list-style-type: none"> <li>• Pattern cannot be eliminated during operation (RUN).</li> <li>• Eliminate the pattern when it is not operating.</li> </ul>
3. <div style="border: 1px solid black; padding: 5px; width: fit-content; margin: 10px auto;">             ERROR                      No. 5 1              P A T T E R N   E X I S T           </div>	<ul style="list-style-type: none"> <li>• Pattern of the copying destination is not cleared.</li> <li>• Confirm the copying destination and do the settings again.</li> </ul>
4. <div style="border: 1px solid black; padding: 5px; width: fit-content; margin: 10px auto;">             ERROR                      No. 6 0              P A T T E R N   N O   S E T T I N G           </div>	<ul style="list-style-type: none"> <li>• Pattern of copy source is not set.</li> <li>• Set the pattern of copy source.</li> </ul>
5. <div style="border: 1px solid black; padding: 5px; width: fit-content; margin: 10px auto;">             ERROR                      No. 6 5              A T 1 :   O N L Y   R U N           </div>	<ul style="list-style-type: none"> <li>• AT1 is not starting as screen is not operating (RUN).</li> <li>• Start AT1 after operating (RUN) the screen.</li> </ul>
6. <div style="border: 1px solid black; padding: 5px; width: fit-content; margin: 10px auto;">             ERROR                      No. 6 6              A T 2 :   O N L Y   R E S E T   P R G           </div>	<ul style="list-style-type: none"> <li>• AT2 is not starting as status is not RESET status.</li> <li>• Start AT2 after changing the status to RESET.</li> </ul>
7. <div style="border: 1px solid black; padding: 5px; width: fit-content; margin: 10px auto;">             ERROR                      No. 6 7              A T 3 :   O N L Y   R E S E T   P R G           </div>	<ul style="list-style-type: none"> <li>• AT3 is not starting as status is not RESET status.</li> <li>• Start AT3 after changing the status to RESET.</li> </ul>

<p>8.</p> <div style="border: 1px solid black; padding: 5px; width: fit-content;"> ERROR                      No. 2 3  SV SCOPE OVER </div>	<ul style="list-style-type: none"> <li>▪ SV section of PID number 9 is out of scope.</li> <li>▪ Confirm the SV section and do the settings again.</li> </ul>
<p>9.</p> <div style="border: 1px solid black; padding: 5px; width: fit-content;"> ERROR                      No. 2 1  INVERTED L &gt; H </div>	<ul style="list-style-type: none"> <li>▪ L is exceeding H.</li> <li>▪ Confirm L/H and do the settings again.</li> </ul>
<p>10.</p> <div style="border: 1px solid black; padding: 5px; width: fit-content;"> ERROR                      No. 2 4  INVERTED Z &gt; S </div>	<ul style="list-style-type: none"> <li>▪ Z is exceeding S.</li> <li>▪ Confirm Z/S and do the settings again.</li> </ul>
<p>11.</p> <div style="border: 1px solid black; padding: 5px; width: fit-content;"> ERROR                      No. 2 5  LINEAR RANGE OVER </div>	<ul style="list-style-type: none"> <li>▪ Linear range is exceeding the scope of measurement range.</li> <li>▪ Confirm the measurement range and do the settings again.</li> </ul>
<p>12.</p> <div style="border: 1px solid black; padding: 5px; width: fit-content;"> ERROR                      No. 6 8  F. B. AT : ONLY RESET </div>	<ul style="list-style-type: none"> <li>▪ FB tuning is not starting as the status is not RESET status.</li> <li>▪ Start FB tuning after making the status as RESET.</li> </ul>
<p>13.</p> <div style="border: 1px solid black; padding: 5px; width: fit-content;"> ERROR                      No. 3 7  PATTERN SELECT EXT </div>	<ul style="list-style-type: none"> <li>▪ As pattern selection system or program drive system has selected exterior, operation cannot be done by front key.</li> <li>▪ When doing the operation by front key, change the pattern selection system.</li> </ul>
<p>14.</p> <div style="border: 1px solid black; padding: 5px; width: fit-content;"> ERROR                      No. 6 1  STEP REPEAT MISS </div>	<ul style="list-style-type: none"> <li>▪ Operation cannot be started as there is an error in step repetition setting.</li> <li>▪ Start the operation after reconfirming the settings.</li> </ul>
<p>15.</p> <div style="border: 1px solid black; padding: 5px; width: fit-content;"> ERROR                      No. 7 0  PID : ONLY RESET </div>	<ul style="list-style-type: none"> <li>▪ Control algorithm is not changed because of operating program.</li> <li>▪ Stop the program operation and change the control algorithm.</li> </ul>
<p>16.</p> <div style="border: 1px solid black; padding: 5px; width: fit-content;"> ERROR                      No. 7 1  TIME : ONLY RESET </div>	<ul style="list-style-type: none"> <li>▪ Time is not changed because of not reset condition.</li> <li>▪ Change to the reset condition and change the time.</li> </ul>



### 7-14-2. System error display

If an abnormality occurs in the system, the following error messages are displayed for around 2 seconds. Confirm the contents of the error message and contact the dealer or our nearest office.

Error message	Error contents
1. <div style="border: 1px solid black; padding: 5px; width: fit-content;">             SYSTEM ERROR No. 01              CALIBRATION ERROR           </div>	<ul style="list-style-type: none"> <li>• Calibration data abnormality</li> </ul>
2. <div style="border: 1px solid black; padding: 5px; width: fit-content;">             SYSTEM ERROR No. 06              RAM BACK UP ERROR           </div>	<ul style="list-style-type: none"> <li>• Battery backup abnormality</li> </ul>
3. <div style="border: 1px solid black; padding: 5px; width: fit-content;">             SYSTEM ERROR No. 10              A/D COUNT : PV           </div>	<ul style="list-style-type: none"> <li>• Abnormality in A/D conversion for PV</li> </ul>
4. <div style="border: 1px solid black; padding: 5px; width: fit-content;">             SYSTEM ERROR No. 11              A/D COUNT : RJ           </div>	<ul style="list-style-type: none"> <li>• Abnormality in A/D conversion for RJ</li> </ul>

### 7-14-3. Warning display

If proper settings and operation is not done, following error messages are displayed for around 3 seconds. Confirm the contents of the warning message and do the proper settings and operation again.

Warning message	Warning contents
1. <div style="border: 1px solid black; padding: 5px; width: fit-content;">             WARNING No. 10              KEY LOCK           </div>	<ul style="list-style-type: none"> <li>• Setting is not changed because of the [Lock] condition at the mode screen.</li> <li>• Change the setting after canceling the [Lock] condition.</li> </ul>

## 8. Initial settings

In '7. Setting screen' setting screen for each mode is explained, but you need not set all of them. The customer should select and set the required parameters depending on the specifications of the controller, system configuration of final product, control conditions etc.

Procedure for setting the minimum limit which is always to be done in the beginning for the finished product is explained here. Do the other settings as per the requirement.

: Always set

: Set as per the requirement

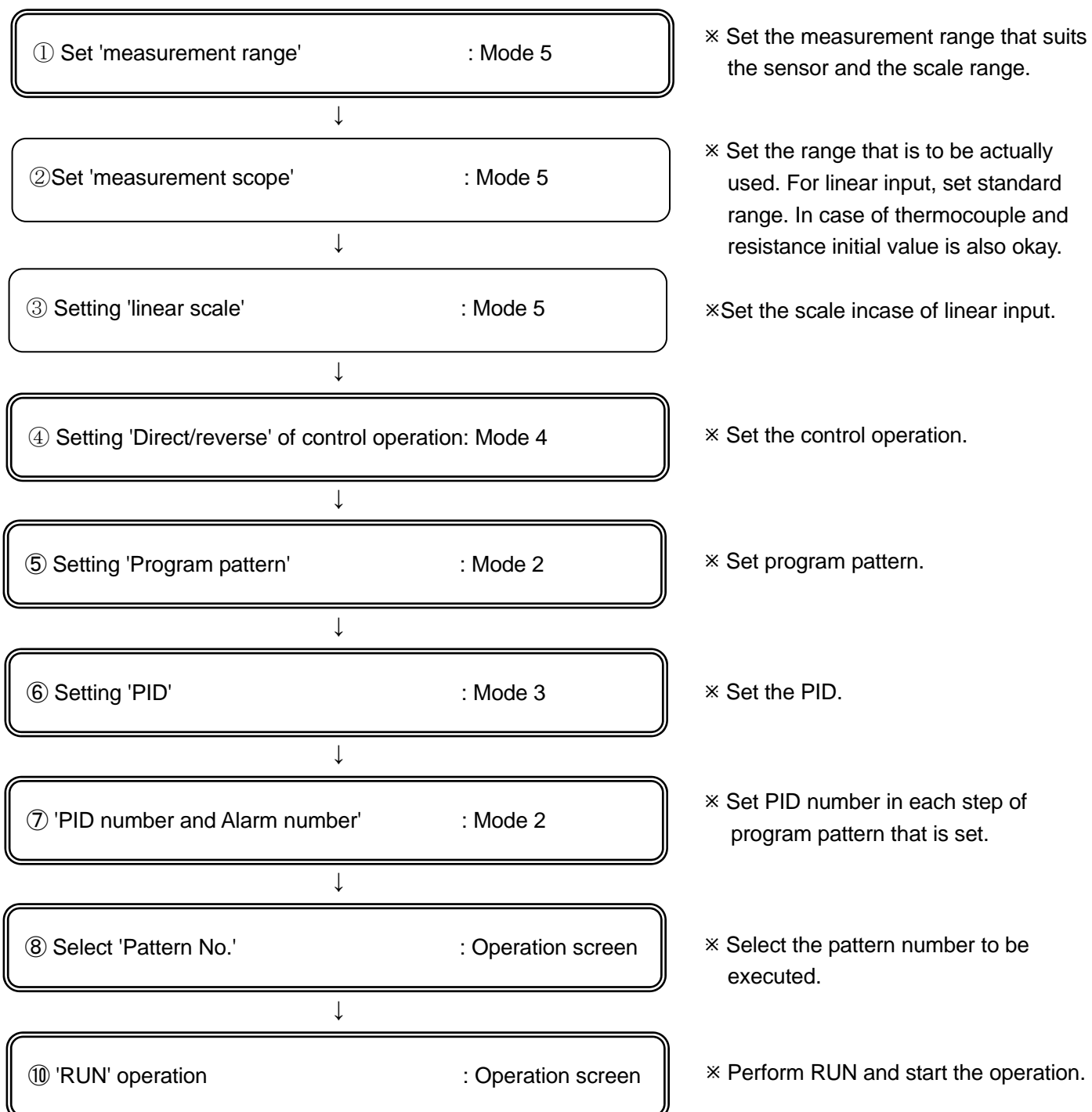

# 9. Operation

## 9-1. Confirmations before operation



Confirm the following contents before starting the operation.



















Item	Confirmation contents
1. Wiring	<ul style="list-style-type: none"> <li>Confirm that the wiring is correct. Especially confirm very properly the wiring of high voltage parts like power supply, output and alarm. Confirm that the terminal screw is not loose.</li> <li>Confirm the wiring of not only the controller but also of the entire finished product. Especially proper confirmation of periphery of actuator (thyristor regulator, heater, motor etc.) is important.</li> </ul>
2. Power supply	<ul style="list-style-type: none"> <li>Confirm that the power supply is in the rating range.</li> </ul>
3. Set contents	<ul style="list-style-type: none"> <li>Confirm that the set contents are correct. When power supply is inserted confirm that the status is RESET status. In RUN status control operation is started immediately. As per the requirement if output is not to be displayed, set 0% in manual output operation.</li> </ul>





 <b>Precautions</b>	<p>① If power supply other than the rated power supply is connected, this controller may become out of order, or its performance may deteriorate or it may malfunction etc.</p> <p>② If excessive current or excessive voltage is applied to input/output terminal of this controller, this controller may become out of order, or its performance may deteriorate or it may malfunction etc.</p>
--	---

## 9-2. Program operation and run operation

### 9-2-1. Run operation

Status	Key operation and operation screen	Description
1.RESET	<p>[Key operation] In operation screen, click the  key and then click  key.</p> <p>[Operation screen] </p>	<ul style="list-style-type: none"> <li>Resets (release) the program operation.</li> <li>It is enabled in RUN status or STOP status.</li> <li>RESET status is the status in which program operation is not executing, output value is 0% and alarm operation does not run.</li> <li>When the step number is progressing due to program operation, the step number returns to '00' due to RESET operation.</li> <li>In case of constant value operation in RESET status, as it is a normal control operation, alarm operation is also executed.</li> </ul>

<p>2.RUN</p>	<p>In [Key operation] operation screen, click  key after clicking  key.</p> <p>[Operation screen]</p> 	<ul style="list-style-type: none"> <li>• It is RUN of program operation.</li> <li>• It is enabled in RESET status or STOP status.</li> <li>• Execute control operation according to the program pattern.</li> <li>• If RUN is executed in RESET status, program operation starts. If RUN is executed in STOP status, program operation reopens.</li> </ul>
<p>3.STOP</p>	<p>In [key operation] operation screen, click  key after clicking  key.</p> <p>[Operation screen]</p> 	<ul style="list-style-type: none"> <li>• STOP of program operation.</li> <li>• It is enabled in RUN status.</li> <li>• If STOP is executed in RUN status, program pattern (SV and time) is stopped and at that time control operation is continued using SV (It becomes a constant value operation).</li> </ul>
<p>4.ADV</p>	<p>In [key operation] operation screen click  key after clicking  key.</p> <p>[Operation screen]</p> 	<ul style="list-style-type: none"> <li>• It is advancing (progress) of step.</li> <li>• It is enabled in STOP status or RESET status.</li> <li>• If ADV operation is done in RUN status, the program operation continues from the beginning of advance step. If ADV operation is done in STOP status, the program operation has STOP status at the beginning of advance step.</li> <li>• In one time ADV operation, progress is by one step hence perform those many number of ADV operations for the number of progress steps.</li> </ul>
<p>5.PTN</p>	<p>In [key operation] operation screen click  key after clicking  key.</p> <p>After that select a number using,  key  key.</p> <p>[Operation screen]</p> 	<ul style="list-style-type: none"> <li>• Select Pattern number.</li> <li>• It is enabled in RESET status.</li> <li>• Pattern number selection status is obtained in RESET status by clicking  key after  key. After that, by using the  key or  key, select the pattern number for which operation is to be done. At that time the number selected in No. of PTN is displayed in upper display window.</li> </ul>

6.FAST	<p>In [key operation] operation screen click  key after clicking  key.</p> <p>[Operation screen]</p> 	<ul style="list-style-type: none"> <li>It is the FAST (fast forward) status of program pattern.</li> <li>It is enabled in RUN status.</li> <li>If RUN operation is done again in RUN status, the program pattern progresses from a speed of 'number of times' to a speed of 'ten times that number' only when  key is clicked. When  key is released, FAST status in cancelled.</li> <li>In case of FAST status, output value (MV) and alarm output maintain the output status that was there just before the FAST operation however time signal outputs depending on the program pattern. However the time error becomes bigger.</li> <li>ADV operation progresses till the beginning of step number however the fast operation can progress up to the middle of program pattern (or step).</li> </ul>
--------	--	---

If run operation is done, words indicating that run operation are displayed in 3 step snap display on the left side of the operation screen.

### 9-2-2 Procedure of program operation

When considering that program pattern and each parameter is set, the start/end procedure of program operation is as follows.

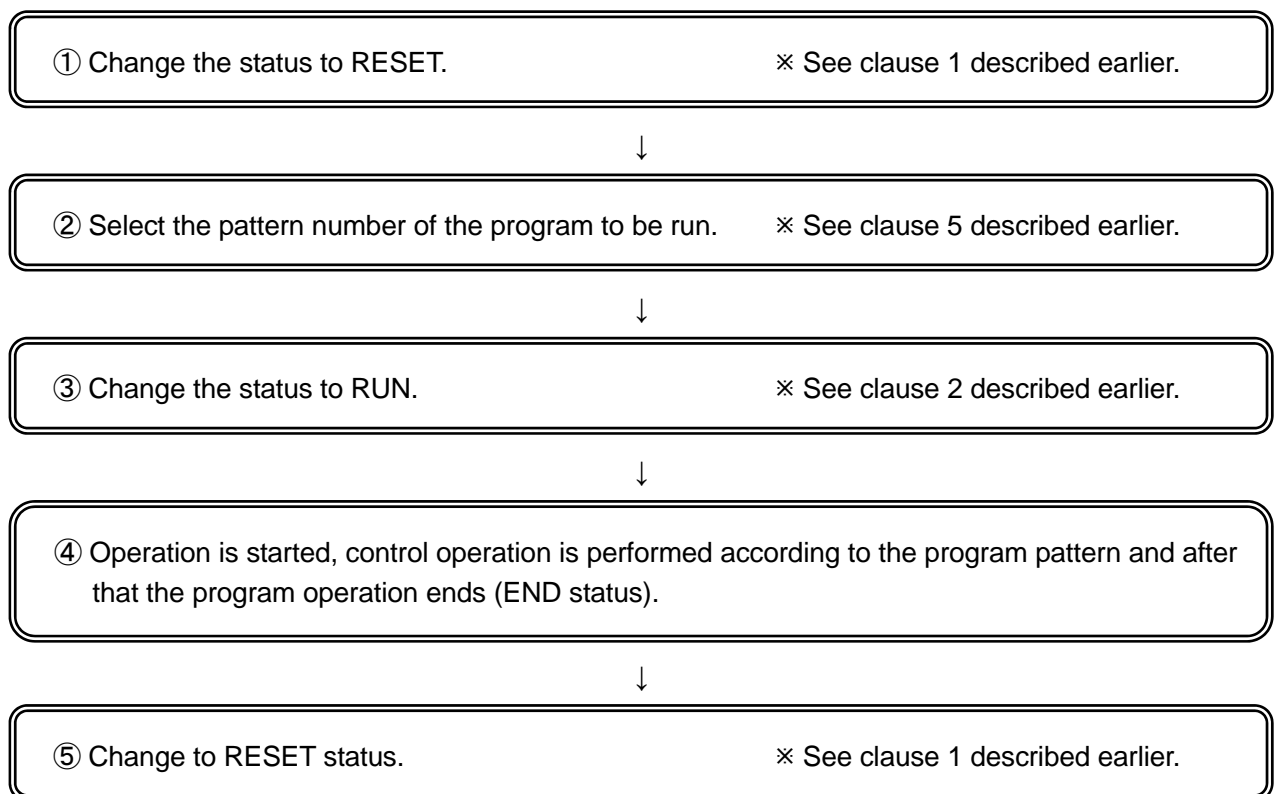

### 9-3. Trial operation

After the confirmations before operation is done, refer to the following and start the trial operation and do various confirmations. This procedure is an example of the most basic trial operation procedure. Add the confirmation contents depending on specifications of the controller, system configuration of finished product, control conditions etc.

① Start the power supply. Considering the safety, preferably make the output in RESET status when power supply is started as 0% or output as 0% in manual output operation such that the control output of the controller is 0%.



② Confirm that the instrument configuring the system that includes the controller also, is normal.



③ Confirm that all the signal levels (voltage value, current value, ON/OFF signal etc.) connected between the instrument configuring the system that includes the controller also, is normal.



④ When output format is current output format and thyristor regulator is connected as operation actuator, confirm the setting contents of thyristor. When output format is ON-OFF servo type and motor is connected as actuator, do the actuator adjustment (FB zero span settings). Confirm the settings of thyristor regulator. In other output format also, confirm the actuator and do the adjustment as per the requirement.



⑤ Consider that the controller has a status of 0% output due to manual output operation. Output increases gradually, the operation of the actuator is equivalent to the output value and confirms that it is normal.



⑥ Set appropriate program pattern, start program operation by 'RUN' operation and switch over to automatic output operation and get the auto control status.



⑦ See the status for a while and if the control is stable then there is no problem. However if the control is unstable, adjust the parameters (PID etc.) of the controller. PID can be calculated automatically also by using the auto tuning function.





⑧ Confirm that operation (Alarm, external signal input etc.) with peripheral devices that are connected to the controller is normal.



⑨ Set various parameters of the controller as per the requirement.













⑩ After some time of starting the operation confirm the normality of final product that includes the controller and all the devices configuring the system.

### 9-4 Constant value operation

This controller is exclusively used for program operation and constant value operation can be performed by the following method. Use it as per the requirement.

System	Description
1. Switching from program operation status to constant value operation  [Operation screen] 	① Set 'CONST' in 'control format' of mode 1. <ul style="list-style-type: none"> <li>It becomes a constant value operation by using SV that was obtained when switching over to 'CONST'.</li> <li>For parameters other than SV also, control operation is done using parameters of mode 0.</li> </ul> ② Set desired SV in 'Executing SV and time' of mode 0. <ul style="list-style-type: none"> <li>When changing the SV, set the desired SV in 'Executing SV and time' of mode 0.</li> <li>For parameters other than SV also, set them in mode 0.</li> </ul> ③ When returning to program operation, set 'PROGRAM', in 'Control format' of mode 1. <ul style="list-style-type: none"> <li>When one switches to 'Program', program operation reopens.</li> </ul>
2. Switching from RESET status to constant value operation  [Operation screen] 	① Set 'CONST' in 'control format' of mode 1. <ul style="list-style-type: none"> <li>It becomes a constant value operation by using SV 'Executing SV and time' of mode 0.</li> <li>For parameters other than SV also, control operation is done using parameters of mode 0.</li> </ul> ② Set desired SV in 'Executing SV and time' of mode 0. <ul style="list-style-type: none"> <li>When changing the SV, set the desired SV in 'Executing SV and time' of mode 0.</li> <li>For parameters other than SV also, set using mode 0.</li> </ul> ③ When returning to program operation, set 'PROGRAM', in 'Control format' of mode 1. <ul style="list-style-type: none"> <li>When one switches to 'Program', it becomes a RESET status.</li> </ul>

## 9-5. Automatic output operation and manual output operation

Operation method	Key operation and operation screen	Explanation
<p>Automatic output operation (Auto output)</p>	<p>[Key operation] In automatic output operation, change to the output display screen at operation screen, and click  key after clicking  key.</p> <p>[Operation screen]</p> 	<ul style="list-style-type: none"> <li>Based on SV of the execution number that is selected and on the PV that is being measured, perform the control calculation, calculate the control output value and output it.</li> <li>Usual control operation is this automatic output operation.</li> </ul>
<p>Manual output operation (Manual output)</p>	<p>[Key operation] In manual output operation, change to the output display screen at operation screen, and click  key after clicking  key.</p> <p>[Operation screen]</p> 	<ul style="list-style-type: none"> <li>SV and PV output the control output value that is set irrespective of each other.</li> <li>If you want to switch to manual output operation, after changing to the output display screen at operation screen, click the  key and the  key on the operation screen.</li> <li>Set the output value by  key/ key. Output range is within the output limit range.</li> <li>During automatic/manual switching, the output value does not change suddenly because of balance less bump less function. During manual output operation, 'M' is added before the word 'OUT' of the operation screen.</li> <li>In case of output 2 specifications, switching between automatic/manual can be done separately for operation screen of output 1 side and that of output 2 side.</li> <li>It is popularly called as manual output.</li> </ul>



## 9-6. Precautions during operation

### 9-6-1. Change in settings during operation

When changing the settings during operation any of the settings except partial setting screen can be changed. When settings cannot be changed during operation, error message is displayed during setting change operation. However changing the settings during control operation by using parameter, may adversely affect the control, hence take care.

An example, when a step was changed during execution is given below, please refer to it.

#### ① When SV is changed

An example where in SV1 (setting value) of step n is changed to SV2 is given. In case of this example, please understand that there was a setting value operation in step n+1 before change, however there is no setting value operation in step n+1 after change.

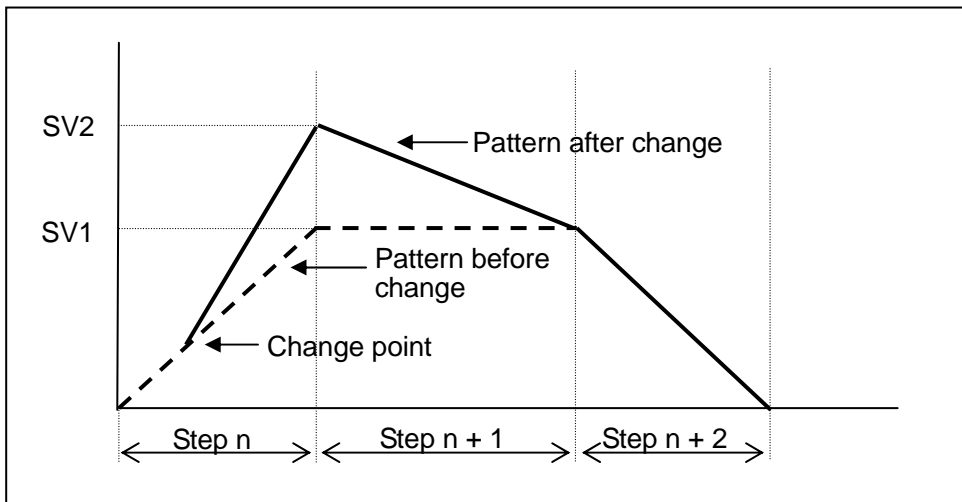

#### ② When TIME is changed

An example wherein TIME (required time) of step n is changed just a little by T is given. On a whole there is a shift of only T minutes.

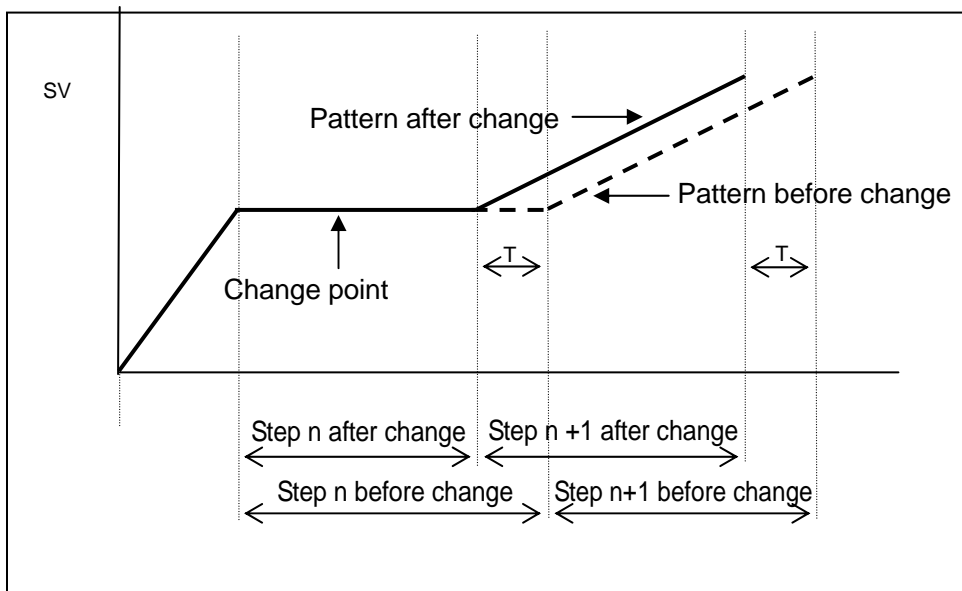

**9-6-2. Precautions when power supply is started**

1. P (proportion) operation when starting the power supply

Even though the settings of PID control are done, only the initial control operation at the time of power supply becomes the P (proportion) operation. As a result, due to the conditions the output value becomes very big momentarily during the power supply, hence take care.

2. Countermeasures against the erroneous output during power supply

During the power supply, until the controller starts normally, output related signals are sometimes momentarily output. Implement the countermeasures against erroneous output as per the requirement by using external circuit.

 <b>Precautions</b>	<ul style="list-style-type: none"><li>① Take care while changing the settings during operation. Control may badly affected by parameters.</li><li>② Supply a good quality and a stable power supply. The controller may malfunction unexpectedly when it is adversely affected by noise, temporary cut off etc.</li></ul>
--	---

# 10. Detailed explanation of main functions

## 10-1 Measurement range

The controller is a universal input type or a 4-wire resistance thermometer type and has various measurement ranges. From among them, select the appropriate measurement range from the sensor and the scale range that is to be actually used. For thermocouple and resistance thermometer, confirm the standards and then select the measurement range. Especially 'Pt100Ω' system of resistance thermometer has three types of standards hence take care.

Displayed measurement range which is set at [measurement range] of mode 5 may be not in order.

[Universal]

No.	Measurement range	Scale range (°C)	Scale range (K)	No.	Measurement range	Scale range (°C)	Scale range (K)		
01	Thermocouple	B	0.0 to 1820.0	273.0 to 2093.0	31	DC voltage	±10mV		
02		R1	0.0 to 1760.0	273.0 to 2033.0	32		±20mV		
03		R2	0.0 to 1200.0	273.0 to 1473.0	33		±50mV		
04		S	0.0 to 1760.0	273.0 to 2033.0	34		±100mV		
05		K1	-200.0 to 1370.0	73.0 to 1643.0	35		±5V		
06		K2	0.0 to 600.0	273.0 to 873.0	37		±10V		
07		K3	-200.0 to 300.0	73.0 to 573.0	36	Direct current	0 to 20mA		
08		E1	-270.0 to 1000.0	3.0 to 1273.0					
09		E2	0.0 to 700.0	273.0 to 973.0					
10		E3	-270.0 to 300.0	3.0 to 573.0					
11		E4	-270.0 to 150.0	3.0 to 423.0					
12		J1	-200.0 to 1200.0	73.0 to 1473.0					
13		J2	-200.0 to 900.0	73.0 to 1173.0	41	Resistance thermometer	JPt100Ω1	-200.0 to 649.0	73.0 to 922.0
14		J3	-200.0 to 400.0	73.0 to 673.0	42		JPt100Ω2	-200.0 to 400.0	73.0 to 673.0
15		J4	-100.0 to 200.0	173.0 to 473.0	44		JPt100Ω4	-200.0 to 200.0	73.0 to 473.0
16		T1	-270.0 to 400.0	3.0 to 673.0	45		JPt100Ω5	-100.0 to 100.0	173.0 to 373.0
17		T2	-200.0 to 200.0	73.0 to 473.0	46		QPt100Ω1	-200.0 to 649.0	73.0 to 922.0
18		WRe5-26	0.0 to 2310.0	273.0 to 2583.0	47		QPt100Ω2	-200.0 to 400.0	73.0 to 673.0
19		W-WRe26	0.0 to 2310.0	273.0 to 2583.0	49		QPt100Ω4	-200.0 to 200.0	73.0 to 473.0
20		NiMo-Ni	-50.0 to 1410.0	223.0 to 1683.0	50		QPt100Ω5	-100.0 to 100.0	173.0 to 373.0
21		CR-AuFe	0.0 to 280.0 K	0.0 to 280.0	51		JPt50Ω	-200.0 to 649.0	73.0 to 922.0
22		N	0.0 to 1300.0	273.0 to 1573.0	53		Pt100Ω1	-200.0 to 850.0	73.0 to 1123.0
23		PR5-20	0.0 to 1800.0	273.0 to 2073.0	54		Pt100Ω2	-200.0 to 400.0	73.0 to 673.0
24		PtRh40-20	0.0 to 1880.0	273.0 to 2153.0	56		Pt100Ω4	-200.0 to 200.0	73.0 to 473.0
25		Platill1	0.0 to 1390.0	273.0 to 1663.0	57		Pt100Ω5	-100.0 to 100.0	173.0 to 373.0
26		Platill2	0.0 to 600.0	273.0 to 873.0					
27		U	-200.0 to 400.0	73.0 to 673.0					
28		L	-200.0 to 900.0	73.0 to 1173.0					

[4-wire resistance thermometer]

No.	Measurement range	Scale range (°C)	Scale range (K)	No.	Measurement range	Scale range (°C)	Scale range (K)		
41	Resistance thermometer	JPt100Ω1	-200.0 to 649.0	73.0— 922.0	50	Resistance thermometer	QPt100Ω5	-100.0 to 100.0	173.0 to 373.0
42		JPt100Ω2	-200.0 to 400.0	73.0— 673.0	51		JPt50Ω	-200.0 to 649.0	73.0 to 922.0
44		JPt100Ω4	-200.0 to 200.0	73.0— 473.0	52		Pt-Co	4.0 to 374.0 K	4.0 to 374.0
45		JPt100Ω5	-100.0 to 100.0	173.0— 373.0	53		Pt100Ω1	-200.0 to 850.0	73.0 to 1123.0
46		QPt100Ω1	-200.0 to 649.0	73.0— 922.0	54		Pt100Ω2	-200.0 to 400.0	73.0 to 673.0
47		QPt100Ω2	-200.0 to 400.0	73.0— 673.0	56		Pt100Ω4	-200.0 to 200.0	73.0 to 473.0
49		QPt100Ω4	-200.0 to 200.0	73.0— 473.0	57		Pt100Ω5	-100.0 to 100.0	173.0 to 373.0

[Standard list]

K, E, J, T, R, S, B, N: IEC584 (1977,1982), JIS C 1602-1995, JIS C 1605-1995

WRe5-WRe26, W-WRe26, NiMo-Ni, Platinel II, CR-AuFe, PtRh40-PtRh2: ASTM Vo1.14.03

U, L: DIN43710-1985

Pt100: IEC751 (1995), JIS C 1604-1997

QPt100: IEC751 (1983), JIS C 1604-1989, JIS C 1606-1989

※QPt100Ω is also called old PT100Ω.

JPt100: JIS C 1604-1981, JIS C 1606-1986

JPt50: JIS C 1604-1981

**10-2 .Linear scale**

If linear input (Direct current voltage and direct current) is selected, initial value of linear scale and measurement scope is as follows.

Measurement range	Scale range	Measurement scope (Initial value)	Linear scale (Initial value)
31 10mV	- 10.0 to 10.0 mV	0.00 to 10.00 mV	0.0 to 2000.0
32 20mV	- 20.0 to 20.0 mV	0.00 to 20.00 mV	0.0 to 2000.0
33 50mV	- 50.0 to 50.0 mV	0.00 to 50.00 mV	0.0 to 2000.0
34 100mV	-100.0 to 100.0 mV	0.00 to 100.00 mV	0.0 to 2000.0
35 5V	0.0 to 5.0 V	0.000 to 5.000 V	0.0 to 2000.0
37 10V	-10.0 to 10.0 V	0.000 to 10.000 V	0.0 to 2000.0
36 20mA	0.0 to 20.0 mA	4.00 to 20.00 mA	0.0 to 2000.0

Setting procedure is as follows.

- ① For 'measurement scope' of mode 5, set the minimum value and the maximum value of the analog signal that is actually input from the sensor.
- ② For 'linear scale' of mode 5, after confirming how to display that minimum value and maximum value, set the decimal point position and lower limit and upper limit of the scale.
- ③ For example, for 4-20 mA if you want to display 0.00-100.00, the settings are as follows.
  - Measurement scope : 4.000 (minimum value) – 20.000 (Maximum value).
  - Linear scale : DOT2.  
0.00 (Lower limit) -100.00 (Higher limit).

### 10-3. Alarm mode

Following are the 8 types of alarm formats.

- ① DH (Deviation high limit alarm) : Alarm is ON when  $SV$  (setting value)+ Alarm setting value is more than  $PV$  (measurement value).
- ② DHW (Deviation high limit wait alarm) : In a system when high limit deviation alarm has a wait function, wait alarm on until entering normal range. When start RUN at RESET condition, or perform ADV (progress), the status becomes wait status.
- ③ DL (Deviation low limit alarm) : Alarm is ON when  $SV$  (setting value)+ Alarm setting value is more than  $PV$  (measurement value).
- ④ DLW (Deviation low limit wait alarm) : In a system when low limit deviation alarm has a wait function, wait alarm on until entering normal range. When start RUN at RESET condition, or perform ADV (progress), the status becomes wait status.
- ⑤ AH (Absolute value high limit alarm) : Alarm is ON when  $PV$  (measurement value) is more than alarm setting value.
- ⑥ AHW (Absolute value high limit wait alarm) : In a system when high limit absolute value alarm has a wait function, wait alarm on until entering normal range. When start RUN at RESET condition, or perform ADV (progress), the status becomes wait status.
- ⑦ AL (Absolute value low limit alarm) : Alarm is ON when  $PV$  (measurement value) is less than alarm setting value.
- ⑧ ALW (Absolute value low limit alarm wait) : In a system when low limit absolute value alarm has a wait function, wait alarm on until entering normal range. When start RUN at RESET condition, or perform ADV (progress), the status becomes wait status.

\*Alarm calculation is performed when operate program and constant value, not RESET.

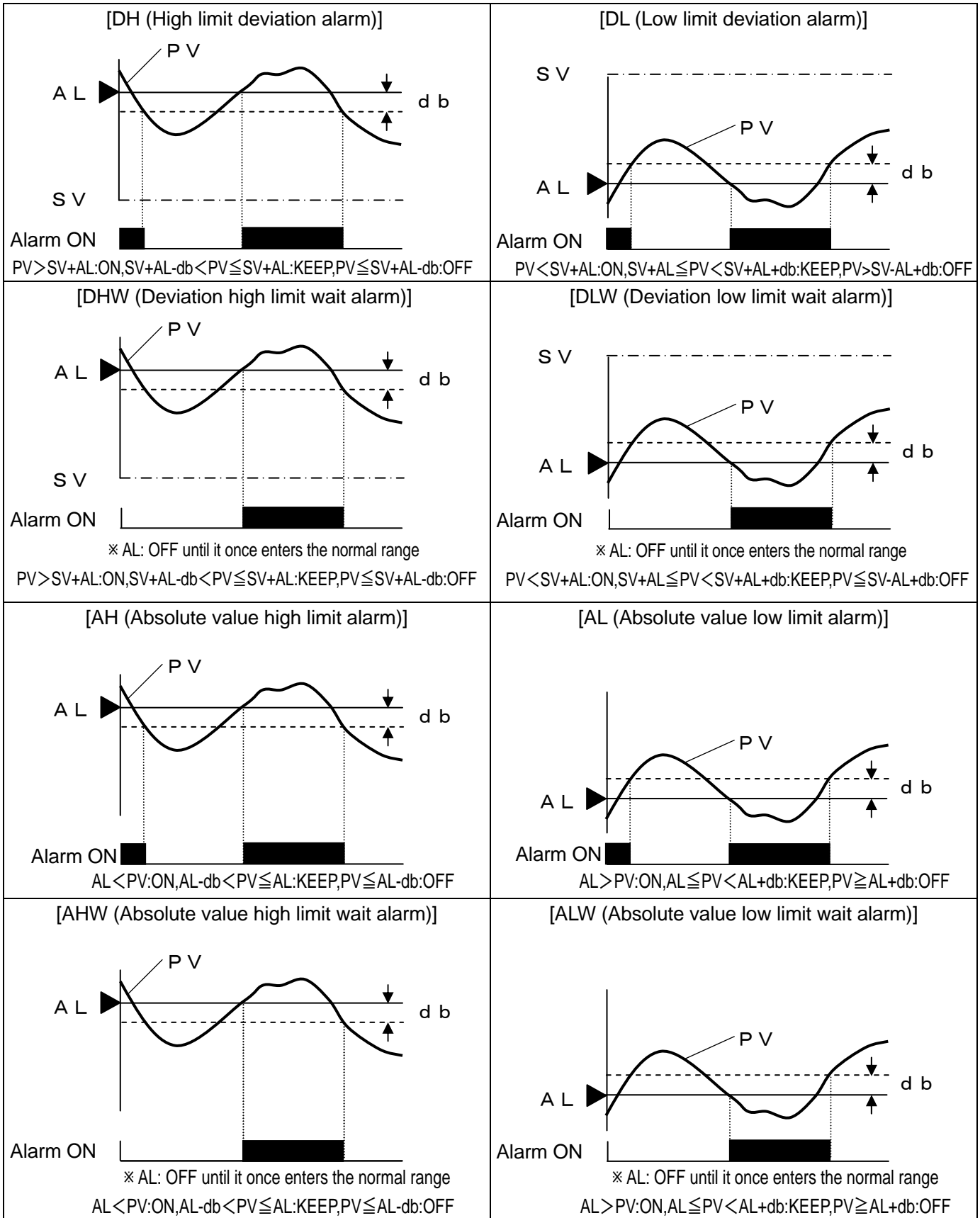
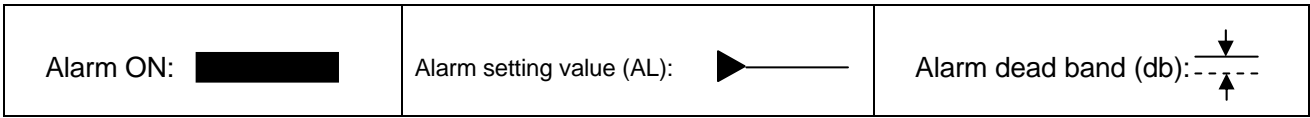

## 10-4. Auto tuning

Auto tuning (AT) is a function that automatically calculates PID constant.

There are three types of auto tunings namely AT1 to AT3 as shown below.

### ① AT1

- It is an auto tuning for output 1.
- It can be executed in RUN status (excluding program end status) or in constant value control status.
- Execute auto tuning by using SV when AT1 is set.
- PID calculated by using AT1, is registered in PID of PID number that is executing.

### ② AT2

- It is an auto tuning for output 1.
- It can be executed in RESET status (excluding constant value control status).
- 8 types of SV for AT2 can be set beforehand and 8 types of PIDs can be calculated according to those.
- PID calculated using AT2, is registered respectively in PID numbers from 1 to 8. ON/OFF of AT can be set for each of the 8 types separately and AT execution of only arbitrary numbers is also possible.

### ③ AT3

- It is an auto tuning for output 1.
- It can be executed in RESET status (excluding constant value control status).
- 8 types of SV for AT3 can be set beforehand and 8 types of PIDs can be calculated according to those.
- PID calculated using AT3, is registered respectively in PID numbers from 9-1 to 9-8. ON/OFF of AT can be set for each of the 8 types separately and AT execution of only arbitrary numbers is possible. ON/OFF of AT can be set for each of the 8 types separately and AT execution of only arbitrary numbers is also possible.

In case of output 2 specifications, MV (output value) of output side of non-executing AT continue to control.

Even when auto tuning start operation is done, PID is not requested normally, sometimes.

Conditions when it is not requested are as follows. In that case, PID constant is not changed and original PID constant remains.

- When response is delayed, when it does not end even after six hour of starting the auto tuning.
- When the value of P calculated by auto tuning is less than 0.1% or more than 1000%.
- When the value of I calculated by auto tuning is less than 1 second.
- When the value of D calculated by auto tuning is less than 1 second.

## 10-5. PID control

PID is the most generic control algorithm which consists of three operations namely P (Proportion), I (Integration) and D (Differentiation).

### ① P operation

- It is the basic operation of PID control. It largely affects the responsiveness and the stability. Offset occurs only in proportion operation.
- If P is increased, the amplitude of PV (measurement value) becomes less and the stability improves however the responsiveness deteriorates.
- By setting P=0% two-position control operation takes place.





### ② I operation

- Offset due to P operation can be eliminated however as the phase is delayed stability deteriorates.
- If I is reduced (integral operation is strengthened), responsiveness improves, over shoot increases.
- Setting value '0' is equivalent to  $\infty$  (infinity).

### ③ D operation

- It compensates the time that is wasted and delay in phase due to delayed elements. However as gain in high frequency area increases, there is a limit for the strength.
- If D is increased, responsiveness increases for a large deviation, however for quick periodic deviations stability deteriorates.
- '0' of the settings value is equivalent to OFF.
- The setting value of D, is  $1/6^{\text{th}}$  to  $1/4^{\text{th}}$  the setting value of I and it is generic.

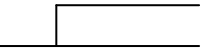
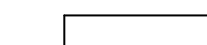
Collectively the PID operation is as follows.

	P (Proportion) operation	I (Integration) operation	D (Differentiation) operation
Input			
Output			

The controller has 2 types of PID control algorithms installed, either of it can be selected.

### ① POSITION

- Position type PID system.
- Comparatively, response is valid for control target.

### ② VELOCITY

- Velocity type PID system.
- Comparatively, response is valid for quick control target.

For theory and details of PID control see its special literature.



## 10-6 Automatic PID switching system

For execution number system, automatic PID switching system makes maximum 8 divisions of SV section in which measurement scope is considered as maximum range and registers a PID number in each of that SV section beforehand. As a result this function operates by using the PID that is registered in each of those SV sections when any of the SV is executed.

Hence once the PID numbers from 9-1 to 9-8 are set, for SV section and automatic PID switching system, even though the SV is changed, there is no trouble of changing the PID accordingly.

Automatic PID switching system is a function of PID for output 1 only. There is only one type of PID for output 2.

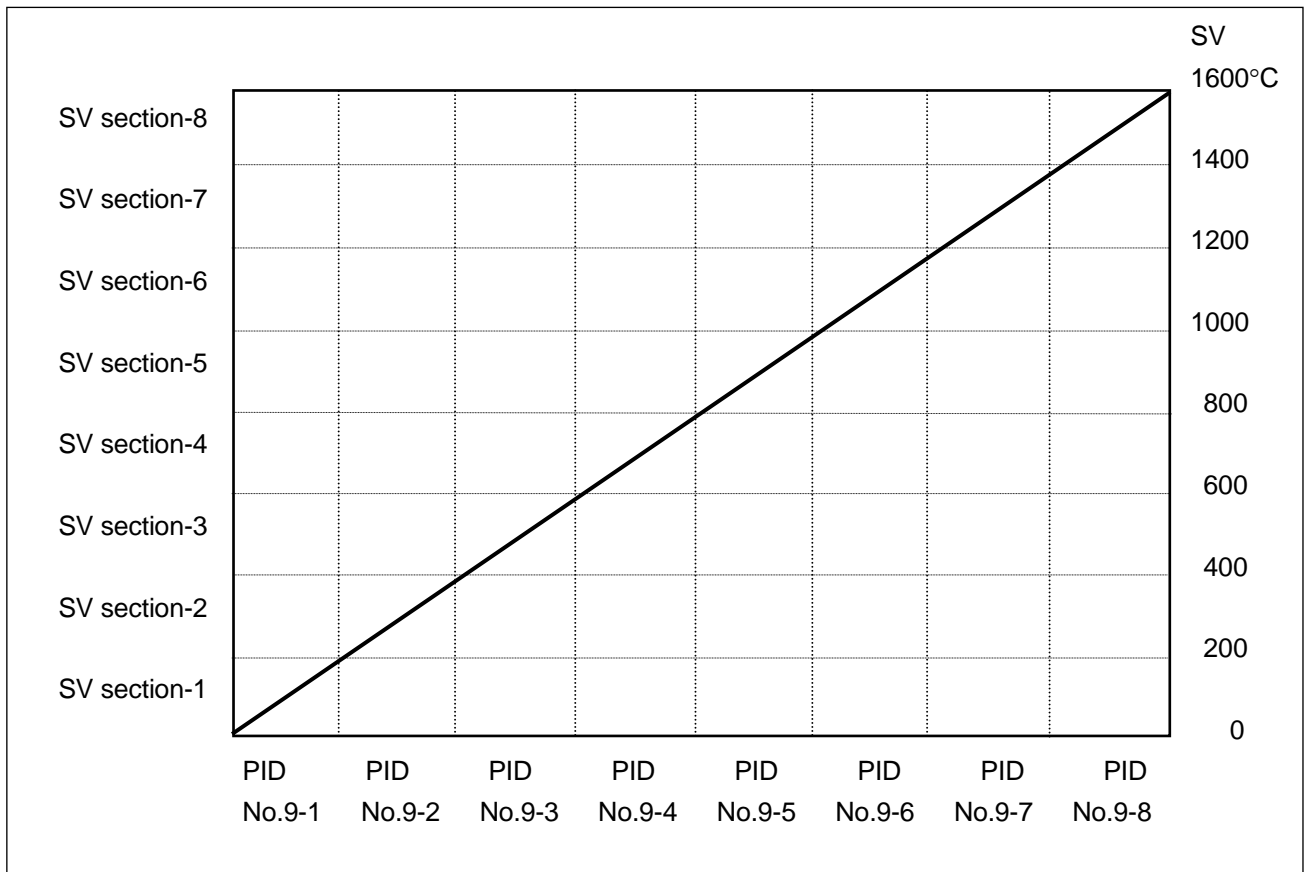

Refer to the above when reading the explanation of setting method.

- ① Setting SV section
  - Confirm the setting range and SV range and decide in how many parts is the SV section to be divided.
  - Set SV section in 'SV section for automatic PID' of mode 3.
  - ※ In the above example, measurement scope is 0 to 1600°C, and for a span of 1600°C eight sections each of 200°C are done and SV section is set.
- ② Setting PID
  - In 'PID 16 types' of mode 3, PID numbers from 9-1 to 9-8 according to the SV section is set.
  - ※ PID can be requested from auto tuning also. Auto tuning that requests PID numbers from 9-1 to 9-8 is AT3.
- ③ Selecting PID system
  - PID number is 'No. 9' in 'PID No. and Alarm No.' of mode 2.

## 10-7. Actuator adjustment of ON-OFF servo type

If the output format is ON-OFF servo type, the controller and the actuator (motor etc.) should be adjusted. Do the adjustment basically by auto adjustment. Fine adjustment can be done manually also, however if you are using it for the first time, use the automatic adjustment first and then the manual fine adjustment. When auto adjustment is not performed, output value of output display screen and feedback value have a margin of error.

### 1. Auto adjustment

#### ① Initializing the setting value

- Before the adjustment, consider the setting value of 'FB dead band' of mode 4 as the initial value.
- For initial value, the dead band becomes 1.0%.
- Other than that for output in the range of 0-100%, confirm each parameter.

#### ② Zero span adjustment

- Select 'START' in 'FB tuning' of mode 4, click **AM/ENT** key and start FB tuning, and then adjusted data of feedback which is displayed at output display screen is initialized.
- The actuator automatically runs on **CLOSE** side and **OPEN** side and calculates the value automatically.
- When FB tuning is completed, return to 'END'.
- The automatically calculated zero span value is automatically registered in 'FB zero span' of mode 4 hence confirm it.

#### ③ Dead band adjustment (Gain adjustment)

- See ⑤ of "Manual adjustment".

If the movement of actuator is delayed too much, auto calculation by 'FB tuning' is not possible. In that case after a fixed period return to 'END' and zero span value is not registered.

### 2. Manual adjustment

#### ① Initializing the setting value

- Before the adjustment, return the setting value of 'FB dead band' and 'FB zero span' of mode 4 to initial value.
- Initial values are zero is 0.0%, span is 100.0% and dead band is 1.0%.
- Other than that for output in the range of 0-100%, confirm each parameter.

#### ② Zero adjustment

- Perform manual output operation (manual output) and set the output value to 0.0%.
- Actuator scales out on **CLOSE** side.
- Increase the output value by 0.1% every time and request an output value that erases **CLOSE** display.

#### ③ Span adjustment

- Similarly the output value is set to 100.0%.
- Actuator scales out on **OPEN** side.
- Decrease the output value by 0.1% every time and request an output value that erases **OPEN** display.

#### ④ Registering zero span value

- Set the output value requested in ① and ②, in 'FB zero span' of mode 4 respectively.

#### ⑤ Dead band adjustment (Gain adjustment)

- Successively, similarly set the output value to 50.0%.
- Increase the setting value a little every time in 'FB dead zone' of mode 4 and request a setting value that erases both the displays of **OPEN** and **CLOSE** of the operation screen.
- Perform a trial operation, increase the setting value little by little until the range where is no error in controllability and set the greatest value as the settings value of final 'FB dead band'.

## 10-8. Output 2

Output 2 specifications of the controller have enabled simultaneous control of heating and cooling.

PID of output 2 and gap between output 1 and output 2 can be set.

Usually, consider output 1 as heating operation and set 'direct/reverse controlling operation' of mode 4 as 'REVERSE' and consider output 2 as cooling operation and set 'direct/reverse controlling operation' of mode 4 as 'DIRECT'.

Gap is as shown in the figure below. It is called the gap between SV and 0% of output 2 (For proportion band).

When both output 1 and output 2 are  $PV=SV$ , if you want output to be 50% (When I operation and D operation are not included), it can be done by requesting a gap  $G(\%) = -P/2$  (P: Proportion band of output 2, output 2 is direct operation).

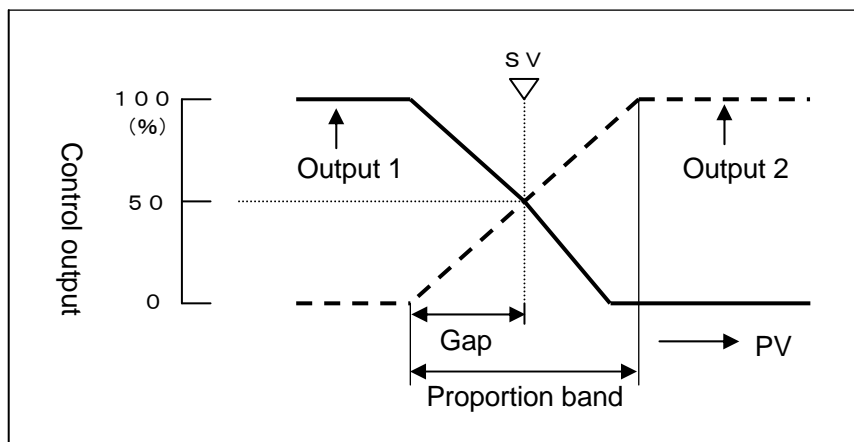

## 10-9. Transmission signal output

It is a function that selects one type from PV (measurement value), SV (measurement value), MV1 (Output value 1), MV2 (Output value 2), MFB (feedback value) and outputs using analog signal.

For example it is used in applications like, selecting a PV transmission and connecting that analog signal to the recorder and recording the PV of this controller in the recorder. Specifications of analog signal are specified in a format.

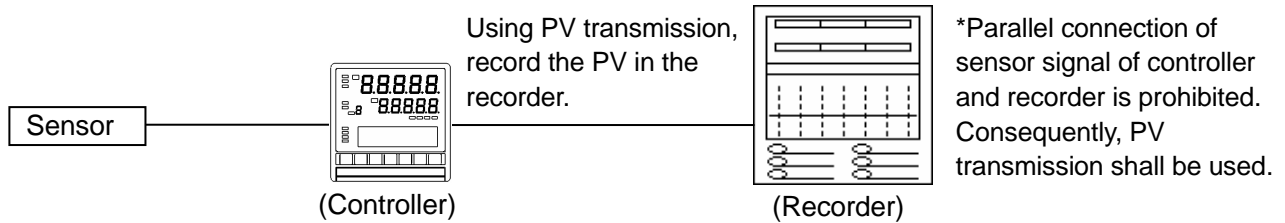

The following occurs when transmission signal output with 4-20mA specified and measurement range K1 and in a range of 0-1200°C transmits PV.

- Set 'PV' in transmission type of mode 7 and '0-1200' in 'transmission scale'.

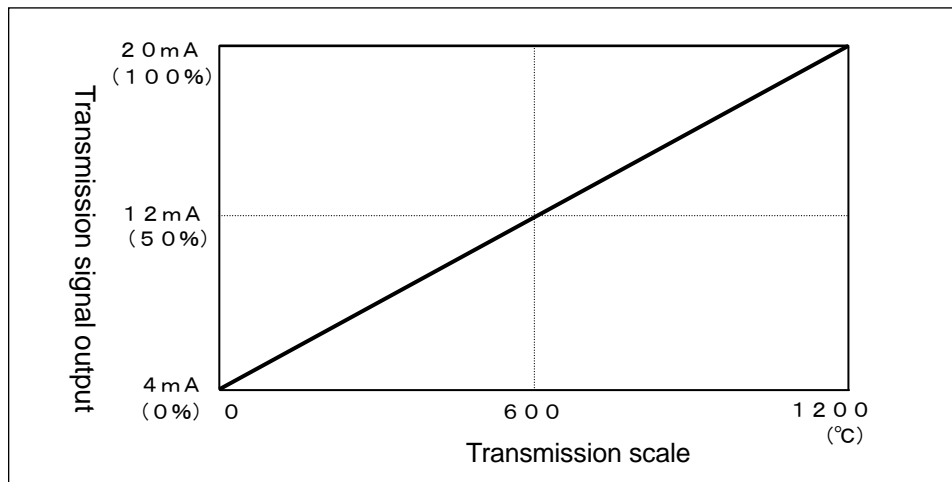

## 10-10. External signal input

In case of specifications with external drive input, this controller can have specific functions by using communication signal (ON/OFF) of external no contact signal (relay, switch, open-collector signal etc.).

Function name	Description
1.RUN/STOP	<ul style="list-style-type: none"> <li>▪ RUN/STOP operation is done by external drive input.</li> <li>▪ It is function of switching between RUN and STOP of program operation.</li> <li>▪ Fixed external signal input is controlled by continuous signal. The status is RUN status after approximately 0.5 seconds or more after conduction (ON) and it is OFF status after approximately 0.5 seconds or more after non-conduction (OFF).</li> <li>▪ It is enabled only when 'MASTER EXT' is selected in 'Program drive system' of mode 1.</li> <li>▪ Execution condition and operation contents etc are same as section 9-2 'Program operation and operation'.</li> </ul>
2.ADV	<ul style="list-style-type: none"> <li>▪ ADV operation is done by external drive input.</li> <li>▪ It is a function to ADV (Advance: Progress) the step of program pattern.</li> <li>▪ Fixed external signal input is controlled by momentary signal. Conduction (ON) is done for approximately 0.5 seconds or more and when it becomes non conducting (OFF) it advances (ADV) only by 1 step</li> <li>▪ It is enabled only when 'MASTER EXT' is selected in 'Program drive system' of mode 1.</li> <li>▪ Execution condition and operation contents etc are same as section 9-2 'Program operation and operation'.</li> </ul>
3.RESET	<ul style="list-style-type: none"> <li>▪ RESET operation is done by external drive input.</li> <li>▪ It is a function for resetting the program operation.</li> <li>▪ Fixed external signal input is controlled by momentary signal. RESET status is obtained after around 1.0 seconds or more after conduction (ON). In order to return to normal status after RESET, choose non conduction (OFF) directly.</li> <li>▪ It is enabled only when 'MASTER EXT' is selected in 'Program drive system' of mode 1.</li> <li>▪ Execution condition and operation contents etc are same as section 9-2 'Program operation and operation'.</li> </ul>
4.WAIT	<ul style="list-style-type: none"> <li>▪ Operation function exclusively for external drive input.</li> <li>▪ It is a WAIT function for program operation. WAIT means stopping the program operation temporarily. In case of WAIT status, program operation is stopped by SV and time that exists just before WAIT and control operation is inherited by that SV. It is a function that is mainly used at the time of slave synchronous operation.</li> <li>▪ Fixed external signal input is controlled by continuous signal. The status is WAIT status after approximately 0.5 seconds or more after conduction (ON).</li> <li>▪ It is enabled only when 'MASTER EXT' is selected in 'Program drive system' of mode 1.</li> </ul>

Function name	Description																																																																																																																														
5.PTN 1 PTN 2 PTN 4 PTN 8 PTN10	<ul style="list-style-type: none"> <li>• Pattern number (PTN) is selected by external signal input.</li> <li>• Pattern number selection is based on control signal due to BCD code.</li> <li>• Fixed external signal input is controlled by continuous signal. See the example table below, depending on the pattern number to be selected, conduct (ON) external signal input with ○ mark. Pattern number is selected in around 0.5 seconds after conduction (ON). It is possible to select conducting patterns except ○ mark depend on the pattern number. For example, when select pattern No. 10, select conducting PTN8 and PTN2.</li> </ul> <table border="1" data-bbox="357 483 1401 775"> <thead> <tr> <th></th> <th>PTN No.9</th> <th>PTN No.8</th> <th>PTN No.7</th> <th>PTN No.6</th> <th>PTN No.5</th> <th>PTN No.4</th> <th>PTN No.3</th> <th>PTN No.2</th> <th>PTN No.1</th> </tr> </thead> <tbody> <tr> <td>PTN10</td> <td>x</td> <td>x</td> <td>x</td> <td>x</td> <td>x</td> <td>x</td> <td>x</td> <td>x</td> <td>x</td> </tr> <tr> <td>PTN 8</td> <td>○</td> <td>○</td> <td>x</td> <td>x</td> <td>x</td> <td>x</td> <td>x</td> <td>x</td> <td>x</td> </tr> <tr> <td>PTN 4</td> <td>x</td> <td>x</td> <td>○</td> <td>○</td> <td>○</td> <td>○</td> <td>x</td> <td>x</td> <td>x</td> </tr> <tr> <td>PTN 2</td> <td>x</td> <td>x</td> <td>○</td> <td>○</td> <td>x</td> <td>x</td> <td>○</td> <td>○</td> <td>x</td> </tr> <tr> <td>PTN 1</td> <td>○</td> <td>x</td> <td>○</td> <td>x</td> <td>○</td> <td>x</td> <td>○</td> <td>x</td> <td>○</td> </tr> </tbody> </table> <table border="1" data-bbox="357 775 1506 1066"> <thead> <tr> <th></th> <th>PTN No.19</th> <th>PTN No.18</th> <th>PTN No.17</th> <th>PTN No.16</th> <th>PTN No.15</th> <th>PTN No.14</th> <th>PTN No.13</th> <th>PTN No.12</th> <th>PTN No.11</th> <th>PTN No.10</th> </tr> </thead> <tbody> <tr> <td>PTN10</td> <td>○</td> <td>○</td> <td>○</td> <td>○</td> <td>○</td> <td>○</td> <td>○</td> <td>○</td> <td>○</td> <td>○</td> </tr> <tr> <td>PTN 8</td> <td>○</td> <td>○</td> <td>x</td> <td>x</td> <td>x</td> <td>x</td> <td>x</td> <td>x</td> <td>x</td> <td>x</td> </tr> <tr> <td>PTN 4</td> <td>x</td> <td>x</td> <td>○</td> <td>○</td> <td>○</td> <td>○</td> <td>x</td> <td>x</td> <td>x</td> <td>x</td> </tr> <tr> <td>PTN 2</td> <td>x</td> <td>x</td> <td>○</td> <td>○</td> <td>x</td> <td>x</td> <td>○</td> <td>○</td> <td>x</td> <td>x</td> </tr> <tr> <td>PTN 1</td> <td>○</td> <td>x</td> <td>○</td> <td>x</td> <td>○</td> <td>x</td> <td>○</td> <td>x</td> <td>○</td> <td>x</td> </tr> </tbody> </table> <ul style="list-style-type: none"> <li>• When BCD code with pattern number other than 1-19 is selected, the pattern number that is selected earlier remains.</li> <li>• It is enabled only when 'EXT' is selected in 'Pattern selection system' of mode 1.</li> <li>• As an example if only pattern numbers 1-4 need to be selected, only three external signal inputs of PTN 1, PTN 2, PTN 3, PTN 4 can be assigned.</li> <li>• Execution condition and operation contents etc are same as section 9-2 'Program operation and operation'.</li> </ul>		PTN No.9	PTN No.8	PTN No.7	PTN No.6	PTN No.5	PTN No.4	PTN No.3	PTN No.2	PTN No.1	PTN10	x	x	x	x	x	x	x	x	x	PTN 8	○	○	x	x	x	x	x	x	x	PTN 4	x	x	○	○	○	○	x	x	x	PTN 2	x	x	○	○	x	x	○	○	x	PTN 1	○	x	○	x	○	x	○	x	○		PTN No.19	PTN No.18	PTN No.17	PTN No.16	PTN No.15	PTN No.14	PTN No.13	PTN No.12	PTN No.11	PTN No.10	PTN10	○	○	○	○	○	○	○	○	○	○	PTN 8	○	○	x	x	x	x	x	x	x	x	PTN 4	x	x	○	○	○	○	x	x	x	x	PTN 2	x	x	○	○	x	x	○	○	x	x	PTN 1	○	x	○	x	○	x	○	x	○	x
	PTN No.9	PTN No.8	PTN No.7	PTN No.6	PTN No.5	PTN No.4	PTN No.3	PTN No.2	PTN No.1																																																																																																																						
PTN10	x	x	x	x	x	x	x	x	x																																																																																																																						
PTN 8	○	○	x	x	x	x	x	x	x																																																																																																																						
PTN 4	x	x	○	○	○	○	x	x	x																																																																																																																						
PTN 2	x	x	○	○	x	x	○	○	x																																																																																																																						
PTN 1	○	x	○	x	○	x	○	x	○																																																																																																																						
	PTN No.19	PTN No.18	PTN No.17	PTN No.16	PTN No.15	PTN No.14	PTN No.13	PTN No.12	PTN No.11	PTN No.10																																																																																																																					
PTN10	○	○	○	○	○	○	○	○	○	○																																																																																																																					
PTN 8	○	○	x	x	x	x	x	x	x	x																																																																																																																					
PTN 4	x	x	○	○	○	○	x	x	x	x																																																																																																																					
PTN 2	x	x	○	○	x	x	○	○	x	x																																																																																																																					
PTN 1	○	x	○	x	○	x	○	x	○	x																																																																																																																					

## 10-11. External signal output

In case of specifications with external drive input, this controller can output externally the time signal and various status signals by using open-collector signal.

Function name	Description
1.TS1 TS2 TS3 TS4 TS5	<ul style="list-style-type: none"> <li>It is a time signal (continuous signal).</li> <li>There are 5 types of time signals from TS 1 to TS 5. When time signal is ON output signal is ON.</li> </ul>
2.RUN/STOP	<ul style="list-style-type: none"> <li>It is the status signal of RUN/STOP (continuous signal).</li> <li>When operation status is RUN output signal is ON and when it is STOP output signal is OFF.</li> </ul>
3.ADV	<ul style="list-style-type: none"> <li>It is the status signal of ADV (momentary signal).</li> <li>When operation status signal is ADV (Advance: Progress) output signal is ON only for around 0.5 seconds.</li> </ul>
4.RESET	<ul style="list-style-type: none"> <li>It is the status signal of RESET (Continuous signal).</li> <li>When operation status is RESET, output signal is ON.</li> </ul>
5.WAIT	<ul style="list-style-type: none"> <li>It is the status signal of WAIT (Continuous signal).</li> <li>When operation status is WAIT, output signal is ON.</li> <li>WAIT means waiting during real temperature compensation and in external signal input the status is WAIT at the time of ON.</li> </ul>
6.END	<ul style="list-style-type: none"> <li>It is the status signal of END (Continuous).</li> <li>When operation status is END (program end) output signal is ON.</li> </ul>

Operation status and status signal are shown together in the diagram as follows.

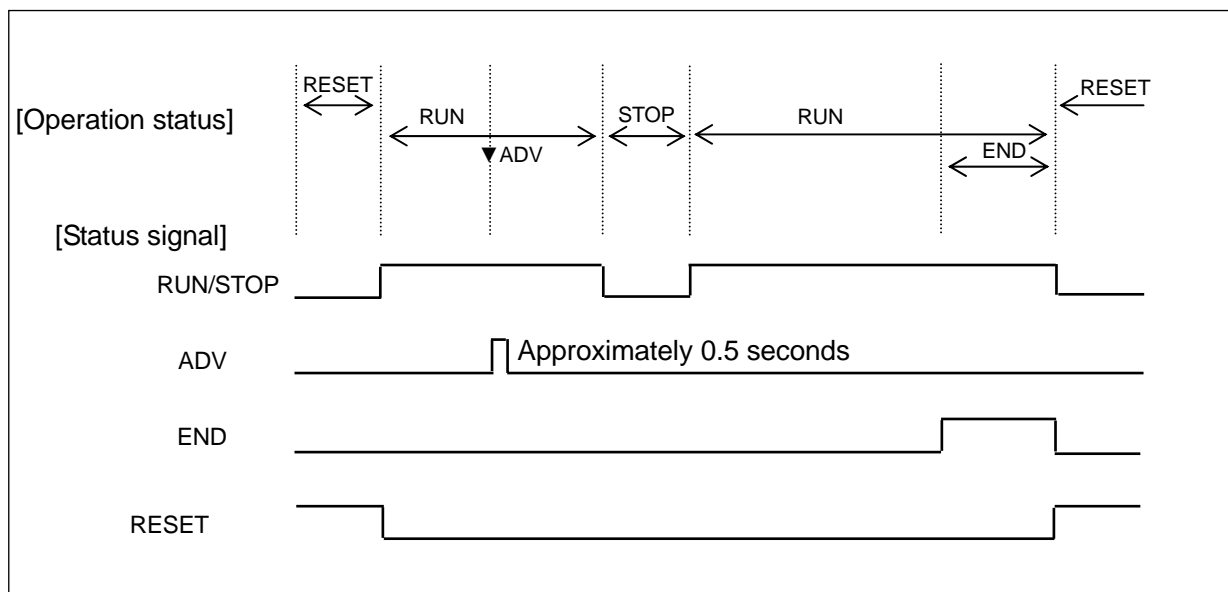

## 10-12. Master slave synchronous operation

In case of specifications with external drive input, by combining external drive input and status signal for a number of KP series unit and also including real temperature compensation status synchronous program operation can be done.

Even when real time compensation operation takes place, a system that inherits synchronous operation is called master slave synchronous operation and it is one of the excellent functions of KP series. In case of real time compensation operation, when asynchronous operation is okay, it is okay to operate using series connection of general external drive input.

### 1. View point

Combine external drive input and status signal. From among a number of units performing synchronous operation, consider one unit as master instrument and the rest of them as slave instruments. Slave instruments will receive from the master instrument the status signal by using external drive input and will run the program. If any one of the units is in WAIT status during real temperature compensation operation, by sending the status signal of that WAIT to WAIT of external drive input of the master instrument, all the other slave instruments also get the WAIT status. Thus in case of real temperature compensation operation also, a synchronous operation that minimizes temporal errors can be realized.

### 2. Wiring

An example of basic master slave synchronous operation wiring is given below.

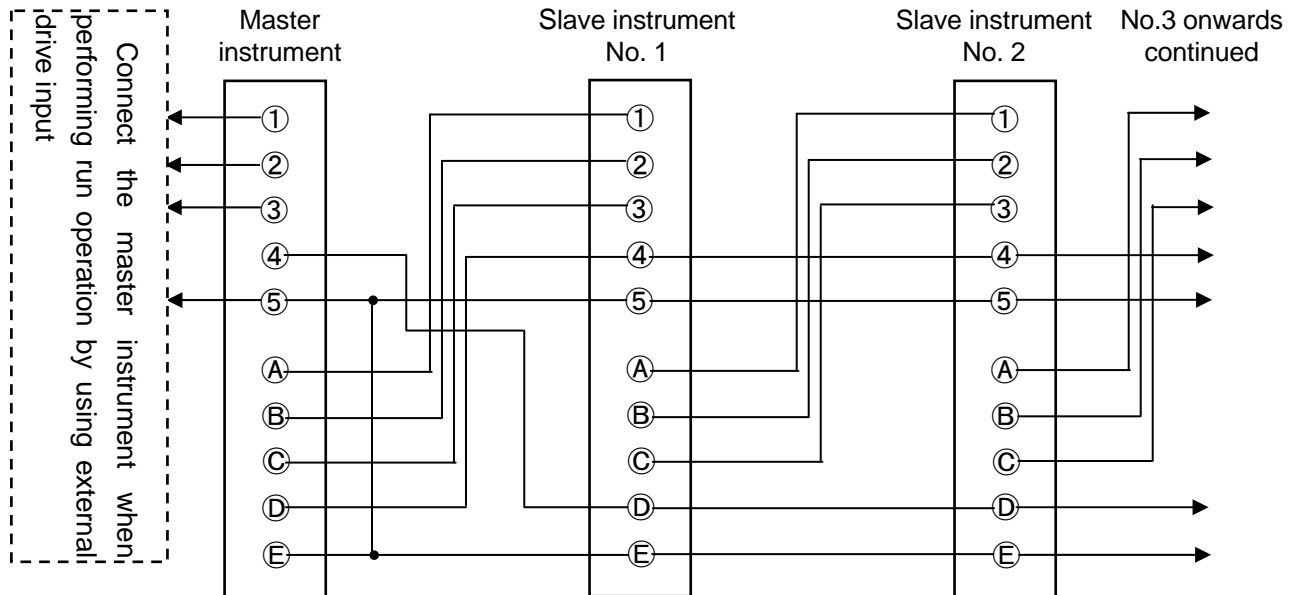

Master drive input		Status signal	
Terminal	Function	Terminal	Function
①	RUN/STOP	A	RUN/STOP
②	ADV	B	ADV
③	RESET	C	RESET
④	WAIT	D	WAIT
⑤	COM	E	COM

※ As terminal is a tentative number, replace it by the terminal number you are using and read.



### 3. Setting

Set the 'Program drive operation' of mode 1 as follows.

	Setting contents
Master instrument	Set from any of the following. <ul style="list-style-type: none"><li>▪ 'MASTER KEY' : Set when performing the run operation using the front key.</li><li>▪ 'MASTER EXT' : Set when performing run operation by using external drive input.</li><li>▪ 'MASTER COM' : Set when performing run operation by communication. However it can be selected only in case of specifications with communication.</li></ul>
Slave instrument	Set all to 'SLAVE EXT'.

### 4. Operation

#### ① Run operation

- Run operation is executed only for master instrument.
- All the slave instruments operate in synchronization with the status signal of master instrument.

#### ② Real temperature compensation operation

- In case of real temperature compensation operation of any one unit, WAIT status signal is output from that one unit, and WAIT signal is sent from master instrument to all the slave instruments. Thus all the connected products are in WAIT status and thus are synchronized.

## **10-13. Communications interface**

The controller is provided with various communications functions and they are as follows.

### **10-13-1. Engineering port**

It is a communications function provided in all the products. Engineering port exists on the right side on the front after opening the lower cover of the front part. Communications with the PC can be done by connecting an exclusive engineering cable (sold separately).

Specifications of communications by using the engineering port is as follows.

- Communications protocol: MODBUS-RTU
- Communications speed: 9600bps
- Communications character: bit length 8/parity NON/stop bit 1

### **10-13-2. Specifications with communications**

Usually when doing communications select specifications with communications. Type of communications can be selected from amongst RS-232C, RS-422A and RS-485.

Communications enables the setting of parameters (Data Write) and data reading (Data Read) by connecting to PC and remote operation for which PC is used and data management can be done. As one more function of KP series, is the communications transmission (digital transmission) function. It is a function which is combined with digital indicating controller DB series which is a sister model, and SV transmission is sent from KP series using communications and by receiving it as remote SV of DB series, using communications, a remote operation without any error at all can be realized. Remote operation due to remote signal input of DB series is called Analog Remote, and remote operation due to communications remote is called Digital Remote.

---

# 11. Engineering port

---

This function can connect with the PC from the front of the controller. Even if this function is not in the specifications with communication interface, it is provided as standard to all products.

An exclusive engineering cable is inserted in this port and connected to the PC.

Parameter setup software 'PASS' is available with our company. Various parameters can be easily set from the front of the controller by using this 'PASS' and engineering cable, and PC.

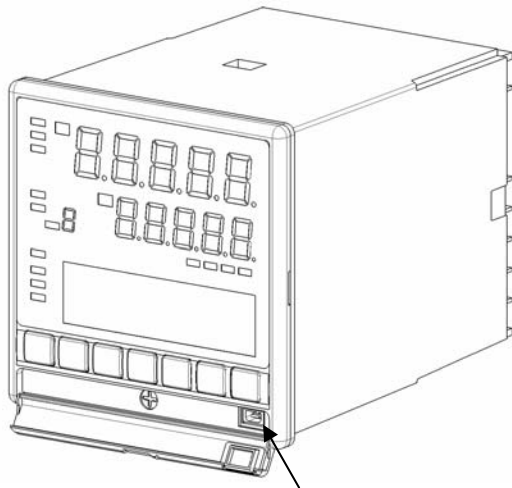

Engineering port

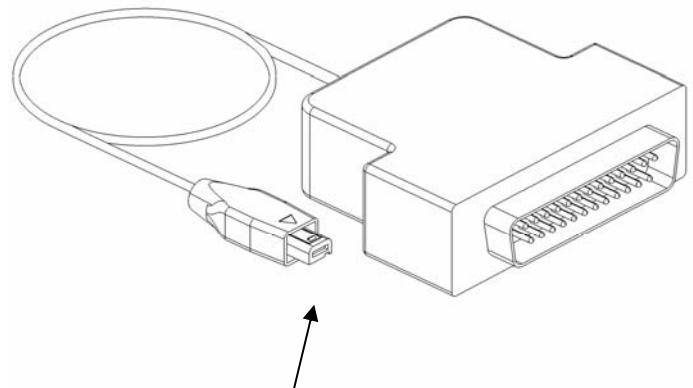

Engineering cable

Engineering port is used for temporary communication connection on that structure and is not for usual connection.

If you want to carry out the communication by usual connection, while purchasing specify specifications with communication interface and do a permanent connection from the back side.



## Precaution

Connecting and disconnecting of engineering cable to engineering port in this instrument should be done while applying power.

## 12. Trouble shooting

Condition	Items to be confirmed
1. There is an error in PV or PV is not stable	<ul style="list-style-type: none"> <li>▪ Confirm that there is no problem in the wiring with the sensor.</li> <li>▪ For thermocouple confirm that wiring is done till the terminal screw by using thermocouple and compensation lead wire.</li> <li>▪ Confirm that the terminal screws are tightened properly.</li> <li>▪ Confirm that sensor signal is not connected in parallel with other instrument.</li> <li>▪ Confirm that protective elements etc are connected to sensor signal and the impedance does not become high.</li> <li>▪ Confirm that there is no problem in output specifications (impedance etc.) and output signal of sensor itself.</li> <li>▪ Confirm that ground terminal is connected to good quality protective ground.</li> <li>▪ Confirm that there is no noise.</li> <li>▪ Confirm that there is no problem in the environment and atmosphere (surrounding temperature, wind etc.)</li> <li>▪ Confirm that set contents of various parameters (Measurement range, sensor correction, customer scale calibration etc) are correct.</li> </ul>
2. PV display becomes '-----'.	<ul style="list-style-type: none"> <li>▪ It indicates excessive input or higher limit burn out for measurement range. Confirm the sensor signal.</li> </ul>
3. PV display becomes '-----'.	<ul style="list-style-type: none"> <li>▪ It indicates very little input or lower limit burn out for measurement range. Confirm the sensor signal.</li> </ul>
4. Control is not stable.	<ul style="list-style-type: none"> <li>▪ Confirm that there is no problem with the wiring of the actuator terminal.</li> <li>▪ Confirm that the terminal screw is tightened properly.</li> <li>▪ Confirm that there is no noise.</li> <li>▪ Confirm that the set contents of various parameters (PID, output limiter etc.) are correct.</li> </ul> <p>※ Regarding controllability, it is necessary to do the design/adjustment not only in just the controller but in the entire system of the final product. If the controllability does not improve even on adjusting the set contents of various parameters (PID etc.) of the controller, consult the designer of this final product.</p>
5. 'ERR' of status display lights.	<ul style="list-style-type: none"> <li>▪ It indicated abnormality in taking the input. In addition to chances of abnormality in the internal circuit of the controller, it might be adversely affected by noise also, hence confirm that there is no noise.</li> </ul>
6. Cause unclear however operation is strange	<ul style="list-style-type: none"> <li>▪ Confirm that the contents of various parameters are correct.</li> <li>▪ Even then if the operation of the controller is strange, initialize the set contents. Do all the settings again and confirm that there is no problem in it.</li> </ul>

Condition	Items to be confirmed
7. Lower display is not displayed normally, displayed strips.	<ul style="list-style-type: none"> <li>▪ Set the proper value of the [Display contrast] in mode11. 40 to 70% of range is suitable setting value. When setting the range of 80 to 100%, stripes appear in the LCD. The setting value is set the initial value (50%) in ordinary use.</li> </ul>
8. Error message is displayed when setting the parameter	<ul style="list-style-type: none"> <li>▪ After confirming error message, change to the correct setting because of the setting which is not registered.</li> </ul>
9. Error message is displayed when starting operations	<ul style="list-style-type: none"> <li>▪ After confirming error message, change to the correct setting because of the setting which is not started operation.</li> </ul>

When problems are not improved after executing the above troubleshooting, contact the dealer or your local CHINO's sales agent.

 <b>Warning</b>	<p>When repair or modification of this instrument is needed, contact the dealer or your local CHINO's sales agent. Make sure that no persons other than service engineers approved by CHINO CORPORATION do not repair or modify this instrument by replacing parts.</p> <p>The data of settings may be deleted during repairing for unexpected trouble (power failure, earthquake, or other unexpected accident).</p> <p>Backup the data of settings before having the instrument repaired. We are not responsible for the lost or damaged data.</p>
---	--

---

---

# 13. Checking and maintenance

---

---

## 13-1. Checking

### 13-1-1. Checking according to the trial operation

Every time before starting the operation do a trial operation and confirm that the final product is correct.

### 13-1-2. Checking the accuracy

For the controller, depending on the requirement of the client periodical accuracy checking is necessary. Due to secular changes, these may slightly drift from accuracy, from the time when it was purchased.

Accuracy checking is done in our company hence consult your dealer or our company's nearest office.

### 13-1-3. Overhaul

Since the controller is reliable, we recommend an overhaul after 2-3 years. For ordering overhaul contact your dealer or our company's nearest office.

## 13-2. Life component

Clear life component of the controller is as follows.

Please understand that secular changes and aging occurs in almost all the products.

Component name	Estimated life
1. Relay × Relay for control, relay for alarm.	Approximately one hundred thousand times
2. Electrolysis condenser × Condenser for smoothness of electric circuit.	Approximately 5 years (Surrounding temperature: 30°C, operation time: 12 hours/day)
3. Lithium battery × Battery for memory backup.	Approximately 10 years (Surrounding temperature: 30°C, operation time: 12 hours/day)

## 13-3. Disposal



### Precautions

- ① A small amount of hazardous substance below the specified level with RoHS directive is included in this controller.
- ② When disposing the controller always request a professional to do it, or dispose the controller in according to the garbage collection method of the each community.
- ③ This controller uses lithium battery. When disposing the controller, always request a professional to do it.
- ④ Separate the box, plastic bags, and cushioning materials the controller is packaged in according to the garbage collection method of the each community, and please cooperate to recycle.

# 14. Explanation of terms

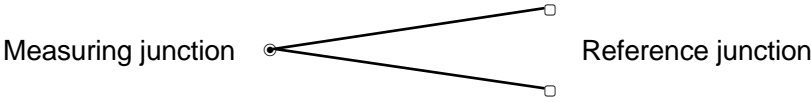
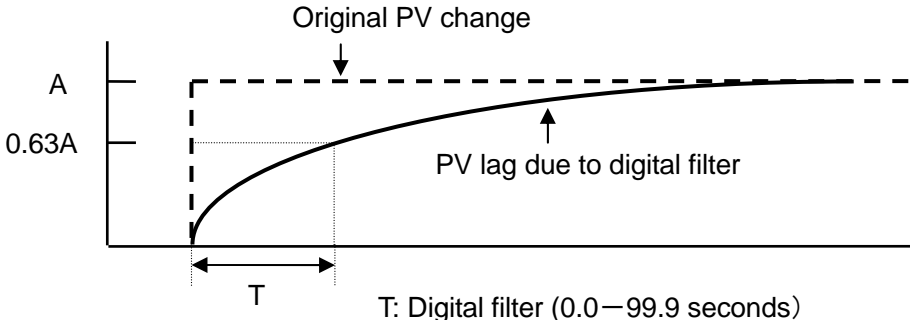
Term	Explanation
Unit	<p>Only for thermocouple or resistance thermometer select °C or K.            Operation equation is as follows.</p> <ul style="list-style-type: none"> <li>• °C = K - 273.15</li> <li>• K = °C + 273.15</li> </ul>
RJ (Reference Junction)	<p>Thermocouple has measurement junction (temperature measurement side) and reference junction (electromotive force generation side) and reference junction decides the standards of thermo-electromotive force table (with scale) at 0°C condition.</p> <div style="text-align: center;">  <p>Measuring junction      Reference junction</p> </div> <p>When connecting the thermocouple to terminal of the controller, usually the temperature of the terminal becomes same as the surrounding temperature and is not 0°C. As a result, unless that temperature is compensated correct temperature cannot be measured. That compensation that is done automatically in the product internally is called the compensation function 'RJ'.</p>
Sensor correction	<p>It is a function that corrects the PV (measurement value).            It can also be used as zero point adjustment of sensor signal.</p>
PV decimal point	<p>It is a function that enables the selection of decimal point function of PV (measurement).            Decimal point position can be selected from 5 digits display.</p>
SV decimal point for display	<p>This is a function for changing position of the decimal point of SV at the upper display. For example, when number of digits after decimal point is not displayed, use this function.</p>
Digital filter	<p>It is a filter function on the operation having first order lag in PV (measurement value).            Setting value of digital filter is equivalent to time constant (T), and when PV is changed during step condition it is equivalent to the time (seconds) to reach approximately 63%.</p> <div style="text-align: center;">  <p style="text-align: center;">T: Digital filter (0.0—99.9 seconds)</p> </div>

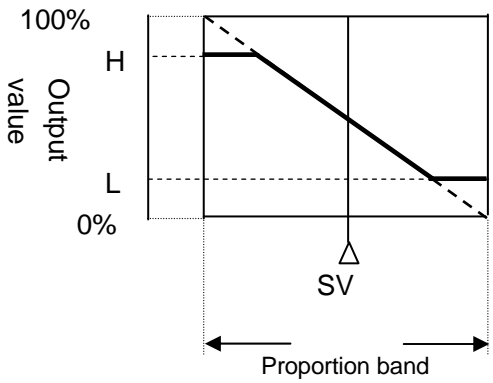
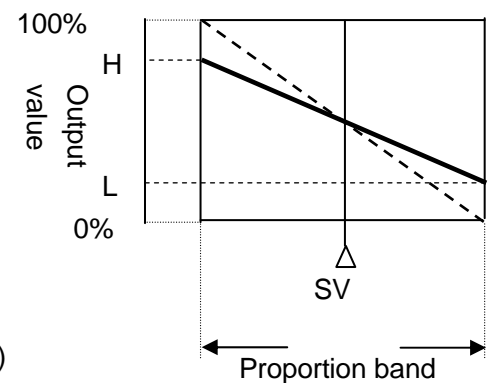
Term	Explanation
Output limiter	<p>It is a function that sets higher Limit and lower limit in a range from -5.0 to 105% in MV.</p> <p>All the MVs (output value) on the control, lie within the range of higher limit and lower limit that is set.</p>  <p>The graph shows 'Output value' on the y-axis with markers for 0%, L, and 100%. A dashed line represents the ideal linear relationship. A solid line shows the actual output, which is constant at the higher limit 'H' until it reaches the set value 'SV', then decreases linearly to the lower limit 'L' at the end of the 'Proportion band'.</p>
Output scale	<p>It is a function that lays out MV from 0.0 to 100%, in a range from higher limit value to lower limit value that is set.</p> <p>All the MVs (output value) on the control, lie within the range of higher limit and lower limit that is set.</p> <p>※ Option (Specify when placing an order)</p>  <p>The graph shows 'Output value' on the y-axis with markers for 0%, L, and 100%. A dashed line represents the ideal linear relationship. A solid line shows the actual output, which is constant at the higher limit 'H' until it reaches the set value 'SV', then decreases linearly to the lower limit 'L' at the end of the 'Proportion band'.</p>
Output variation limiter	<p>It is a function that limits the variation quantity of MV (output value), for each control cycle (approximately 0.1 seconds). For example when variation in MV is 50% and set value of output variation limiter is 5%, then approximately 0.1 seconds x 50 / 5 = approximately 1.0 seconds, to arrive to a variation of 50% approximately 1.0 seconds are required.</p> <p>By using this function appropriately, sudden variation in MV (output value) can be avoided and controllability can be improved.</p> <p>However, manual output (include immediately after switching manual to auto) and output during PV abnormality are not effect this function.</p>
Output preset	<p>It is a function that can set MV (output value) when SV = PV, when controlling only the P (proportion) operation.</p>
Output at the time of PV abnormality	<p>It is a function that considers forcibly MV (output value) as set value when, PV (measurement value) exceeds the range (including higher limit burnout), is below range (including lower limit burnout).</p> <p>Separate settings can be done in case of over range (including higher limit burnout) and under range (including lower limit burnout). In case of internal data abnormality, MV (output value) is the same as that in case of over range (including higher limit burnout).</p>

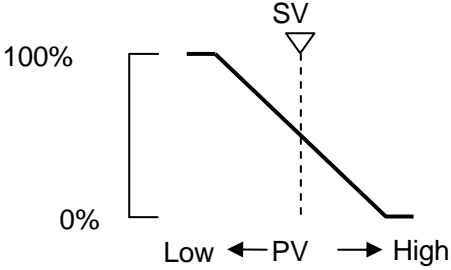
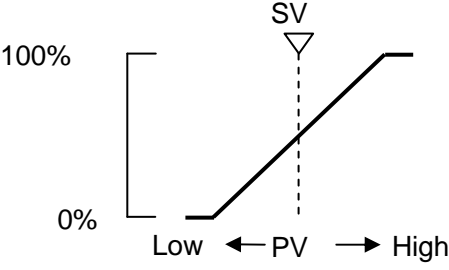
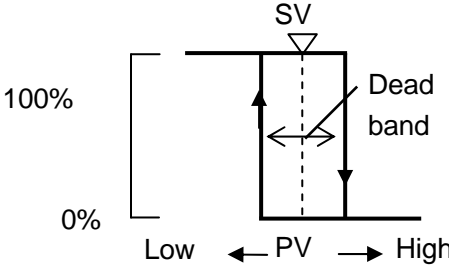
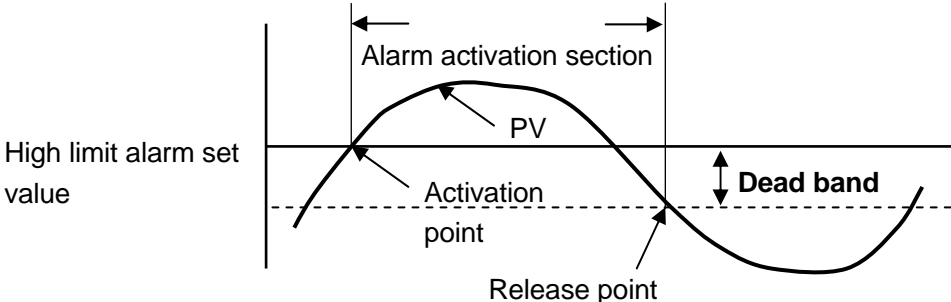

Term	Explanation
Pulse cycle	<p>It is a function that sets one cycle time of output ON/OFF in case of ON-OFF pulse type or SSR drive pulse type.</p> <p>The smaller the set value the better the controllability, however as the ON/OFF count increases the life span of relay etc. decreases. Set the highest possible value in the range such that there is no error in controllability.</p>
Control operation	<p>'Reverse operation' is a control operation for SV (Setting value) in which the lower the PV (measurement value) the bigger the MV (output value) and it is generally used at the time of heating operation.</p> <p>'Direct operation' is a control operation for SV (Setting value) in which the higher the PV (measurement value) the bigger the MV (output value) and it is generally used at the time of cooling operation.</p> <div style="display: flex; justify-content: space-around; align-items: flex-end;"> <div style="text-align: center;"> <p>[Reverse operation]</p>  </div> <div style="text-align: center;"> <p>[Direct operation]</p>  </div> </div>
Output dead band (Two-position control operation)	<p>It is a dead band of output operation of two-position control operation (when P=0%).</p> <p>The smaller the set value the better the controllability, however as the ON/OFF count increases the life span of relay etc. decreases. Set the highest possible value in the range such that there is no error in controllability.</p> <div style="text-align: center;"> <p>[For reverse operation]</p>  </div>
Alarm dead band	<p>It is a function that, activates the alarm at the alarm setting value during alarm activation and releases the alarm when the dead band that is set in the alarm setting value exceeds the dead band that is set in alarm setting value during alarm release.</p> 

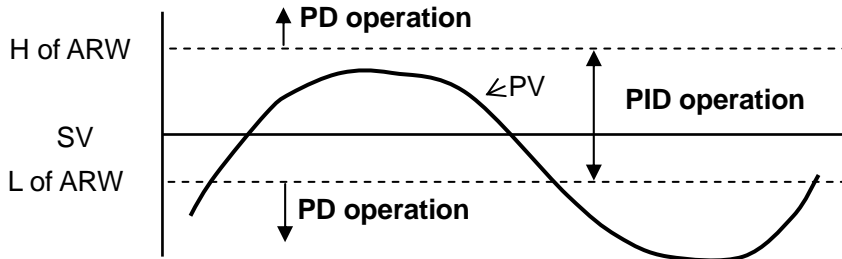
Term	Explanation
Alarm delay	<p>In the function that has delay in alarm output, initial alarm is switched ON, when the judgment time of alarm ON is continuously equal to the setting value or more. If the judgment time of alarm ON, is less than the setting value, alarm is not switched ON.</p> <p>For example, if setting value of alarm delay is 5, when alarm is activated continuously for 5 seconds or more, initial alarm is switched ON. However when alarm is released it is switched OFF immediately.</p>
A.R.W (Anti reset windup)	<p>It is a function that decides the range of PID operation (especially I operation) in position type PID control.</p> <p>If this set value is exceeded, it becomes a PD operation.</p> 
PV start	<p>It is one of the functions in program operation and is a function that starts the SV (setting value) of program pattern from current PV (measurement value).</p> <p>When setting PV start, when operation status is changed from RESET to RUN, the operation starts from first identical SV in program pattern and PV at that time. If identical SV does not exist, SV is started and the operation starts from the first step.</p> <p>When pattern link is set, only initial pattern is enabled.</p>
Real temperature compensation	<p>In program operation, when progressing towards the next new step, if PV (measurement value) as against SV is not less than the setting value of real temperature compensation, when it enters the value less than the setting value stop the time there and perform constant value operation, and move to the next step and perform constant value operation at that point of time.</p> <p>Thus by using this function effectively, control operation according to the program pattern is possible. If set the small value, real temperature compensation may not work because of passing though next input taking.</p>
Wait time alarm	<p>In case of real temperature compensation operation, for value equal to or greater than the setting value of wait time alarm, it is a alarm function when constant value operation time lapses due to real temperature compensation operation.</p>

# 15. Accessories

## 15-1. Front protective cover

Model type is “KP cover”.

It is a cover for protecting the front part also to protect the keys from being tampered.

During closed installation, it is not mounted but it is with front protective cover, the panel mounting interval of the controller is 105 mm or more.

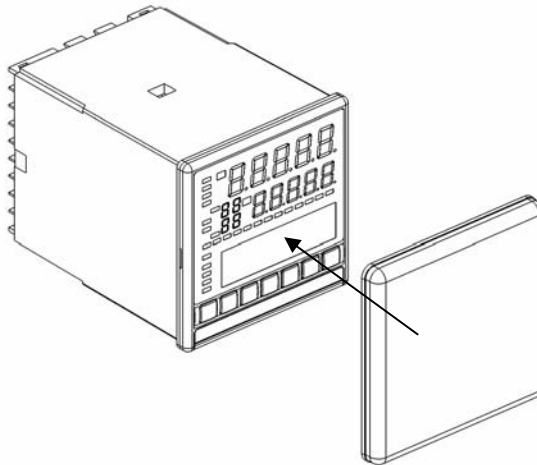

## 15-2. Contact protection element

Contact protection element is connected for noise rejection to the relay output terminal of the controller. Always do the loading and wiring through contact protection element and buffer relay in relay output like ON-OFF pulse type, ON-OFF servo type and alarm output.

Contact protection element as shown below is available with our company also, use it as per your requirement.

Model	Specifications	Open close current	Application
CX-CR1	0.01 $\mu$ F + 120 $\Omega$	Less than 0.2A	For light load
CX-CR2	0.5 $\mu$ F + 47 $\Omega$	0.2A or more	For heavy load

While using it, the leak current flows depending on the load power supply as shown below hence take care.

Model	Power voltage: 200V		Power voltage: 100V	
	50Hz	60Hz	50Hz	50Hz
CX-CR1	Approximately 2mA	Approximately 2mA	Approximately 1mA	Approximately 1mA
CX-CR2	Approximately 45mA	Approximately 55mA	Approximately 23mA	Approximately 28mA

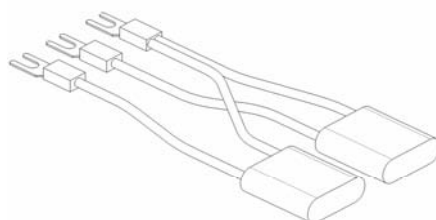

# 16. Specifications

## ■ Input specifications

Input signal:

Thermocouple B, R, S, K, E, J, T, WRe5-WRe26,  
W-WRe26, NiMo-Ni, CR-AuFe, N, PR5-20,  
PtRh40-PtRh20, Platinel II, U, L

DC voltage  $\pm 10\text{mV}$ ,  $\pm 20\text{mV}$ ,  $\pm 50\text{mV}$ ,  $\pm 100\text{mV}$ ,  
 $\pm 5\text{V}$ ,  $\pm 10\text{V}$

DC current 0 to 20mA

Resistance thermometer Pt100, JPt100, Old Pt100,  
JPt50, Pt-Co (4-wires)

Measurement range: Thermocouple 28 types, DC voltage 6  
types, DC current 1 type, resistance  
thermometer 14 types

Temperature unit: °C, K

Accuracy rating:  $\pm 0.1\% \pm 1$  digit of measurement range

For details see, 'Detailed accuracy rating specifications'.

Reference junction compensation accuracy:  $\pm 0.5^\circ\text{C}$

For details see, 'Reference junction compensation accuracy'.

Sampling rate: Approximately 0.1 seconds

Resolution : Approximately 1/30000

Burnout: Restricted to thermocouple, DC voltage (less than  
 $\pm 50\text{mV}$ ), resistance thermometer (3-wire), high limit  
burnout is a standard provision. During burnout,  
output value of output 1 and output 2 can be set  
optionally, and high limit alarm is ON (during high  
limit burnout) however DC voltage ( $\pm 100\text{mV}$  or  
more), DC current, resistance temperature (4 wire  
system) are not provided.

Input impedance: Thermocouple  $1\text{M}\Omega$  or more

DC voltage  $1\text{M}\Omega$  or more

Direct current approximately  $250\Omega$

Allowable signal source resistance:

Thermocouple Less than  $100\Omega$

DC voltage (mV) Less than  $100\Omega$

DC voltage (V) Less than  $300\Omega$

Allowable wire resistance: Resistance thermometer

Less than  $5\Omega$  (Should be common  
for all wires)

Measurement current of resistance thermometer:

Approximately 1mA

Maximum allowable input: Thermocouple Less than  $\pm 20\text{V}$

DC voltage Less than  $\pm 20\text{V}$

DC voltage Less than  $\pm 30\text{mA}$ , Less than  $\pm 7.5\text{V}$

Resistance temperature Less than  $500\Omega$ ,  
Less than  $\pm 5\text{V}$

Maximum common mode voltage: Less than 30VAC

Common mode rejection ratio: 130dB or more (50/60Hz)

Normal mode rejection ratio: 50dB or more (50/60Hz)

## ■ Display specifications

Upper display: LED

Lower display: LCD (with back light) 108x24 dot

## ■ Control specifications

Control cycle: Approximately 0.1 seconds

Output format: ON-OFF pulse type, ON-OFF servo type,  
Current output type, SSR drive pulse type,  
voltage output type

ON-OFF pulse type:

Output signal ON-OFF pulse conductive signal

Contact capacity Resistance load

Less than 100 to 240VAC and 5A

Less than 30VDC and 5A

Inductive load

Less than 100 to 240VAC and 2.5A

Less than 30VDC and 2.5A

Smallest load

5VDC and 10mA or more

Contact protection

Build in a small type of CR device

ON-OFF servo type:

Output signal ON-OFF servo inductive signal

Contact capacity of standard load

Resistance load

Less than 100 to 240VAC and 5A

Less than 30VDC and 5A

Inductive load

Less than 100 to 240VAC and 2.5A

Less than 30VDC and 2.5A

Smallest load

5VDC and 10mA or more

Contact capacity of light load

Resistance load

Less than 100 to 240VAC and 20mA

Less than 30VDC and 20mA

Inductive load

Less than 100 to 240VAC and 20mA

Less than 30VDC and 20mA

Smallest load

5VDC and 1mA or more

Contact protection

Build in a small type of CR device

Current output type

Output signal 4 to 20mA

Load resistance Less than  $750\Omega$

SSR drive pulse type

Output signal ON-OFF pulse voltage signal

Output voltage ON voltage  $12\text{VDC} \pm 20\%$

OFF voltage less than 0.8VDC

Load current Less than 20mA

Voltage output type

Output signal 0 to 10V

Output impedance Approximately  $10\Omega$

Load resistance  $50\text{k}\Omega$  or more

<p>■ Alarm specifications  Alarm points: 4 points  Alarm type: Absolute value alarm, deviation alarm  Output signal: Relay output signal ("a" contact)  COM common for AL1 and AL2, COM common for AL3 and AL4</p> <p>Contact capacity</p> <table border="0"> <tr> <td>Resistance load</td> <td>Less than 100 to 240VAC and 3A Less than 30VDC and 3A</td> </tr> <tr> <td>Inductive load</td> <td>Less than 100 to 240VAC and 1.5A Less than 30VDC and 1.5A</td> </tr> <tr> <td>Smallest load</td> <td>5VDC and 10mA or more</td> </tr> </table> <p>■ General specifications  Rated power voltage: General power supply specifications  100 to 240VAC  24V Power supply specifications  24VAC/24VDC</p> <p>Rated power supply frequency:  General power supply specifications  50/60Hz  24V Power supply specification  DC, 50/60Hz</p> <p>Maximum power consumption:  General power supply specifications</p> <table border="0"> <tr> <td>Without option</td> <td>100VAC 10VA 240VAC 15VA</td> </tr> <tr> <td>With option</td> <td>100VAC 15VA 240VAC 20VA</td> </tr> <tr> <td colspan="2">24V Power supply specifications</td> </tr> <tr> <td>Without option</td> <td>24VAC 10VA 24VAC 5W</td> </tr> <tr> <td>With option</td> <td>24VAC 15VA 24VAC 10W</td> </tr> </table> <p>Power failure countermeasures:  Storing the setting contents using EEPROM  (Rewrite count Less than one million times)</p> <p>Terminal screw: M3.5</p> <p>Insulation resistance:</p> <table border="0"> <tr> <td>Between primary terminal and secondary terminal</td> <td>20MΩ or more (500VDC)</td> </tr> <tr> <td>Between primary terminal and grounding terminal</td> <td>20MΩ or more (500VDC)</td> </tr> <tr> <td>Between secondary terminal and grounding terminal</td> <td>20MΩ or more (500VDC)</td> </tr> </table> <p>Withstand voltage:</p> <table border="0"> <tr> <td>Between primary terminal and secondary terminal</td> <td>1500VAC (For 1 minute)</td> </tr> <tr> <td>Between primary terminal and grounding terminal</td> <td>1500VAC (For 1 minute)</td> </tr> <tr> <td>Between secondary terminal and grounding terminal</td> <td>500VAC (For 1 minute)</td> </tr> </table> <p>※ Primary terminal: Terminal of power supply, control output, and alarm output  Secondary terminal: All terminals except primary terminal, power supply (24VAC/24VDC)</p> <p>Casing: Fire-retardant Polycarbonate  Color: Gray or black  Mounting: Panel maunting  External dimensions: 96(H)x96(W)x127(D)  (Depth from panel screen is 120)</p> <p>Weight: Without option                      Approximately 450g  With option                                      Approximately 580g</p>	Resistance load	Less than 100 to 240VAC and 3A Less than 30VDC and 3A	Inductive load	Less than 100 to 240VAC and 1.5A Less than 30VDC and 1.5A	Smallest load	5VDC and 10mA or more	Without option	100VAC 10VA 240VAC 15VA	With option	100VAC 15VA 240VAC 20VA	24V Power supply specifications		Without option	24VAC 10VA 24VAC 5W	With option	24VAC 15VA 24VAC 10W	Between primary terminal and secondary terminal	20MΩ or more (500VDC)	Between primary terminal and grounding terminal	20MΩ or more (500VDC)	Between secondary terminal and grounding terminal	20MΩ or more (500VDC)	Between primary terminal and secondary terminal	1500VAC (For 1 minute)	Between primary terminal and grounding terminal	1500VAC (For 1 minute)	Between secondary terminal and grounding terminal	500VAC (For 1 minute)	<p>■ Safety standards  CE approval: EN61326: 1997 +A1+A2+A3  EN61010-1:2001  (Over voltage category II, pollution level 2)</p> <p>※ Due to the test condition of EMC directive, indication value or output value which is equivalent to maximum ±10% or maximum ±2mV which ever is greater, changes.</p> <p>UL file No.: E214646  UL :UL61010-1 2<sup>nd</sup> edition  c-UL :CAN/CSA C22.2 No.61010-1-04</p> <p>■ Reference operation condition  Surrounding temperature: 23°C±2°C  Surrounding humidity: 55%RH±5% (With no condensation)  Power voltage: General power supply specifications  100VAC±1%  24V Power supply specifications  24VDC±1%</p> <p>Power supply frequency:  General power supply specifications  50/60Hz±0.5%  24V Power supply specifications  DC</p> <p>Mounting orientation: Forward or backward ±3°, lateral ±3°  Set up height: Altitude below 2000m  Vibrations: 0m/s<sup>2</sup>  Shocks: 0m/s<sup>2</sup></p> <p>Mounting condition: Simple panel mounting  (There should be a space above below and to the right and left)</p> <p>Wind: None  External noise: None  Warm up time: 30 minutes or more</p> <p>■ Normal operation condition  Surrounding temperature: -10°C to 50°C  (-10°C to 40°C for closed installation)  Surrounding humidity: 10 to 90%RH (With no condensation)  Power voltage: General power supply specifications  90 to 264VAC  24V Power supply specifications  21.6 to 26.4VDC/AC</p> <p>Power supply frequency:  General power supply specifications  50/60Hz±2%  24V Power supply specifications  DC,50/60Hz±2%</p> <p>Mounting orientation: Forward or backward±10°, lateral±10°  Set up height: Altitude below 2000m  Vibrations: 2m/s<sup>2</sup>  Shocks: 0m/s<sup>2</sup></p> <p>Mounting condition: Simple panel mounting  (There should be a space above below and to the right and left)</p> <p>External noise: None  Surrounding temperature variation ratio: Less than 10°C/hour</p>
Resistance load	Less than 100 to 240VAC and 3A Less than 30VDC and 3A																												
Inductive load	Less than 100 to 240VAC and 1.5A Less than 30VDC and 1.5A																												
Smallest load	5VDC and 10mA or more																												
Without option	100VAC 10VA 240VAC 15VA																												
With option	100VAC 15VA 240VAC 20VA																												
24V Power supply specifications																													
Without option	24VAC 10VA 24VAC 5W																												
With option	24VAC 15VA 24VAC 10W																												
Between primary terminal and secondary terminal	20MΩ or more (500VDC)																												
Between primary terminal and grounding terminal	20MΩ or more (500VDC)																												
Between secondary terminal and grounding terminal	20MΩ or more (500VDC)																												
Between primary terminal and secondary terminal	1500VAC (For 1 minute)																												
Between primary terminal and grounding terminal	1500VAC (For 1 minute)																												
Between secondary terminal and grounding terminal	500VAC (For 1 minute)																												

■ Transport conditions

Surrounding temperature: -20°C to 60°C

Surrounding humidity: 5 to 90%RH (With no condensation)

Vibrations: 4.9m/s<sup>2</sup> (10 to 60Hz)

Shocks: 392m/s<sup>2</sup>

However these are the factory shipping packing conditions.

■ Storage conditions

Surrounding temperature: -20°C to 60°C

However temperature for long term preservation is 10°C to 30°C.

Surrounding humidity: 5 to 90%RH (With no condensation)

Vibrations: 0m/s<sup>2</sup>

Shocks: 0m/s<sup>2</sup>

However these are the factory shipping packing conditions.

■ Option

[ Transmission signal output]

Number of outputs: Maximum 1

Output signal: 4-20mA (Load resistance Less than 400Ω)

0-1V (Output impedance Approx.10Ω)

(Load resistance More than 50kΩ)

0-10V (Output impedance Approx.10Ω)

(Load resistance More than 50kΩ)

Accuracy rating: High accuracy type ±0.1%FS

Resolution: High accuracy type Approx. 1/30000

Output update period: Approx. 0.1 second

Insulation:

Internal circuit is insulated

(More than 20MΩ and 500VDC)

Transmission signal outputs are also insulated

[Communication Interface]

Communication points: Maximum 1

Communication type: RS-232C, RS-422A, RS-485

Protocol: MODBUS(RTU), MODBUS(ASCII), PRIVATE

Insulation: Internal circuit is insulated (More than 20MΩ/500VDC)

Communication interfaces are not insulated

[Output 2]

Control period: Approx. 0.1 second

Output type: ON/OFF pulse type, Current output type, Voltage output type, SSR drive pulse type. Combinations of these types are also possible

Insulation: Internal circuit is insulated (More than 20MΩ or more and 500VDC)

Outputs are not insulated (Only On/Off pulse type is insulated)

[External signal input]

Number of inputs: Maximum 9

Input signal: No-voltage contact, open-collector signal

External contact capacity: 5VDC · 2mA

Function: RUN/STOP

ADV

RESET

WAIT

Pattern NO. selection

(5 points ofPTN1/PTN2/PTN4/PTN8/PTN10)

Insulation: Internal circuit is insulated (More than 20MΩ or more and 500VDC)

External signal input points are not insulated

[External signal output]

Number of outputs: Maximum 10

Output signal: No-voltage contact, open-collector signal

No-voltage contact, open-collector signal

Function: Timer signal 5 points

(TS1/TS2/TS3/TS4/TS5)

RUN/STOP

ADV

RESET

WAIT

END

Insulation: Internal circuit is insulated (More than 20MΩ or more and 500VDC)

External output points are not insulated

[Panel sealing]

External protection: Corresponding to IEC60529 IP54 (Not possible during closed instrumentation)

[Terminal cover]

Cover the terminals for safe.

■ Detailed specifications of accuracy rating

Input type		Accuracy rating	Exceptional specifications
Thermocouple	B	±0.1%FS ±1 digit	0 to 400°C: Out of specifications 400 to 800°C: ±0.2%FS ±1digit
	R, S		0 to 400°C : ±0.2%FS ±1digit
	N		
	K		-200 to 0°C: ±0.2%FS ±1digit or ±60μV equivalent value, whichever is bigger
	E		-270 to 0°C: ±0.2%FS ±1digit or ±80μV equivalent value, whichever is bigger
	J		-200 to 0°C: ±0.2%FS ±1digit or ±80μV equivalent value, whichever is bigger
	T		-270 to 0°C: ±0.2%FS ±1digit or ±40μV equivalent value, whichever is bigger
	U		-200 to 0°C: ±0.2%FS ±1digit or ±40μV equivalent value, whichever is bigger
	L		-200 to 0°C: ±0.2%FS ±1digit
	WRe5-WRe26		
	W-WRe26		0 to 400°C: ±0.3%FS ±1digit
	NiMo-Ni		
	Platinel II		
	CR-AuFe		±0.2%FS ±1 digit
PR5-20	0 to 100°C: Out of specifications 100 to 200°C: ±0.5%FS ±1digit		
PtRh40-PtRh20	0 to 400°C: ±1.5%FS ±1digit 400 to 800°C: ±0.8%FS ±1digit		
DC voltage/DC current		±0.1%FS ±1 digit	
Resistance temperature	Pt100 Old Pt100 JPt100	±0.1%FS ±1 digit	Applicable when measurement range is “-100 to 100°C”, -100 to 100°C: ±0.15%FS ±1digit
	JPt50		
	Pt-Co	±0.15%FS ±1 digit	4 to 20K : ±0.5%FS ±1digit 20 to 50K : ±0.3%FS ±1digit

※ It is the measurement range conversion accuracy in reference operating conditions. Reference compensation accuracy is added in case of Thermocouple.

※ K, E, J, T, R, S, B, N: IEC584(1977, 1982), JIS C 1602—1995, JIS C 1605—1995

WRe5-WRe26, W-WRe26, NiMo-Ni, Platinel II, CR-AuFe, PtRh40-PtRh20: ASTM Vol. 14. 03

U, L: DIN43710—1985

Pt 100Ω: IEC751(1995), JIS C 1604—1997

Old Pt 100Ω: IEC751(1983), JIS C 1604—1989, JIS C 1606—1989

JPt 100Ω: JIS C 1604—1981, JIS C 1606—1986

JPt 50Ω: JIS C 1604—1981

■ Reference compensation accuracy

Thermocouple type	Ambient temperature: 23°C±10°C	Ambient temperature: Range other than mentioned on left
K, E, J, T, N, Platinel II	±0.5°C Or ±20μV equivalent value, whichever is more	±1.5°C Or ±60μV equivalent value, whichever is more
Other than mentioned above	±1.0°C Or ±40μV equivalent value, whichever is more	±3.0°C Or ±120μV equivalent value, whichever is more

※ It is the compensation accuracy considered when measurement input value in 0°C. In case of measurement value other than 0°C, above-mentioned electromotive force conversion equivalent value is considered as the compensation accuracy.

# 17. Parameter list

## [Parameters not linked to Program Pattern]

Mode NO.	Setting Item		Default value (During default settings)	Customer setting value	Setting range
0	Running SV and time	SV	0000.0		Measurement scope, linear scale
		Time	000:00		000:00 to 999:59
	Running PID	P	005.0%		000.0 to 999.9 (0 is two-position control)
		I	0060s		0000 to 9999 (0 is ∞)
		D	0030s		0000 to 9999 (0 is OFF)
	Running second output PID	P	005.0%		000.0 to 999.9 (0 is two-position control)
		I	0060s		0000 to 9999 (0 is ∞)
		D	0030s		0000 to 9999 (0 is OFF)
	Running alarm 1 and alarm 2	AL1	3000.0		-1999.9 to 3000.0
		AL2	-1999.9		
	Running alarm 3 and alarm 4	AL3	3000.0		
		AL4	-1999.9		
	Running output limiter	L	000.0%		-05.0 to 100.0
		H	100.0%		000.0 to 105.0
Running output variation limiter	UP	100.0%		000.1 to 100.0	
	DOWN	-100.0%		-100.0 to -000.1	
	Running sensor compensation		0000.0		-199.99 to 200.00
1	Running operation key lock		UNLOCK		UNLOCK, LOCK
	Alarm output cancellation		NON		NON, RESET
	Auto tuning		END		END, AT1, AT2, AT3
	Program drive method		MASTER KEY		MASTER KEY, MASTER EXT SLAVE EXT, MASTER COM
	Pattern selection method		KEY		KEY, EXT, COM
	Time display method		PASS STEP		PASS STEP, PASS PATTERN REMAIN STEP REMAIN PATTERN
	Adjustment mode		PROGRAM		PROGRAM, CONST
2	Clear pattern		END		EACH (01 to 19), ALL
	Copy pattern		END		PTN: (01 to 19) → (01 to 19) , YES
	SV during Reset		0000.0		Measurement scope, linear scale
	Time unit		HOUR:NIN		HOUR:MIN, MIN:SEC
3	A.R.W	L	-050.0%		-100.0 to 000.0
		H	050.0%		000.0 to 100.0
	Second output PID	P	005.0%		000.0 to 999.9 (0 is two-position control)
		I	0060s		0000 to 9999 (0 is ∞)
		D	0030s		0000 to 9999 (0 is OFF)
Second output gap		000.0%		-100.0 to 100.0	



Mode NO.	Setting Item		Default value (During default settings)	Customer setting value	Setting range
3	Output dead band		0.5%		0.1 to 9.9
	Second output dead band		0.5%		0.1 to 9.9
	Alarm mode	AL1	DH		DH, DL
		AL2	DL		DHW, DLW
		AL3	DH		AH, AL
		AL4	DL		AHW, ALW
	Alarm dead band	AL1	002.00		000.00 to 200.00
		AL2	002.00		
		AL3	002.00		
AL4		002.00			
Alarm delay		0000.0s		0000.0 to 2000.0	
AT2, AT3 start direction		UP		UP, DOWN	
Control Algorithm		POSITION		POSITION, VELOCITY	
4	Second output limiter (or second output scale)	L	000.0%		-05.0 to 100.0
		H	100.0%		000.0 to 105.0
	Second output variation limiter	UP	100.0%		-000.1 to 100.0
		DOWN	-100.0%		-100.0 to -000.1
	Output when program ends	OUT1	CONTROL		CONTROL, -005.0 to 105.0
		OUT2	CONTROL		CONTROL, -005.0 to 105.0
	Output preset		050.0%		-100.0 to 100.0
	Pulse cycle		030s		001 to 180
	Second output pulse cycle		030s		000 to 180
	FB tuning		END		END, START
	FB zero span	Z	00.0%		00.0 to 99.9
		S	100.0%		000.1 to 100.0
	FB dead band		1.0%		0.5 to 5.0
	Output during PV error	OVR	000.0%		-05.0 to 105.0
		UVR	000.0%		
Output during second output PV error	OVR	000.0%		-05.0 to 105.0	
	UVR	000.0%			
Direct/Reverse control		REVERSE		DIRECT, REVERSE	
Direct/Reverse control for output 2		DIRECT		DIRECT, REVERSE	
5	Measurement range	Universal	K1		Refer to "Measurement range list"
		4-wire resistance thermometer	Pt100Ω1		Refer to "Measurement range list"
	RJ		INT		INT, EXT
	Unit		°C		°C, K
	Measurement range		-200.0 to 1370.0		Measurement range scale
	Linear scale	DOT	1		0 to 4
		Scale	0000.0 to 2000.0		-1999.9 to 3000.0
	PV point		1		0 to 4
Digital filter		00.1s		00.0 to 99.9	
SV decimal point for display		1		0 to 4	
7	Transmission type		PV		PV, SV, MV (MV1, MV2), MFB
	Transmission scale		-0200.0 to 1370.0		-1999.9 to 3000.0

Mode No.	Setting item	Initial value (During default settings)	Customer setting value	Setting range
8	Communication speed	9600bps		2400, 4800, 9600, 19200, 38400
	Instrument number	01		01 to 99
	Communication function	COM		COM, TRANS
	Communication/Transmission type	PV		PV, SV, MV(MV1, MV2), MFB
	Communication protocol	MODBUS(RTU)		MODBUS(RTU), MODBUS(ASCII), PRIVATE
	Communication character	8BIT/NON/STOP1		7BIT/EVEN/STOP1 - - - 8BIT/ODD/STOP2
11	Display backlight	AUTO		GREEN, ORANGE, AUTO
	Display contrast	050%		000 to 100
	Key backlight	AUTO		AUTO, OFF, ON

**[Parameters linked to Program Pattern]**

MODE2

Pattern No.		Pattern repeat: No/Yes ( Times)	Pattern Link: No/Yes (Link destination pattern No.)
Setting range	0000 to 9999		

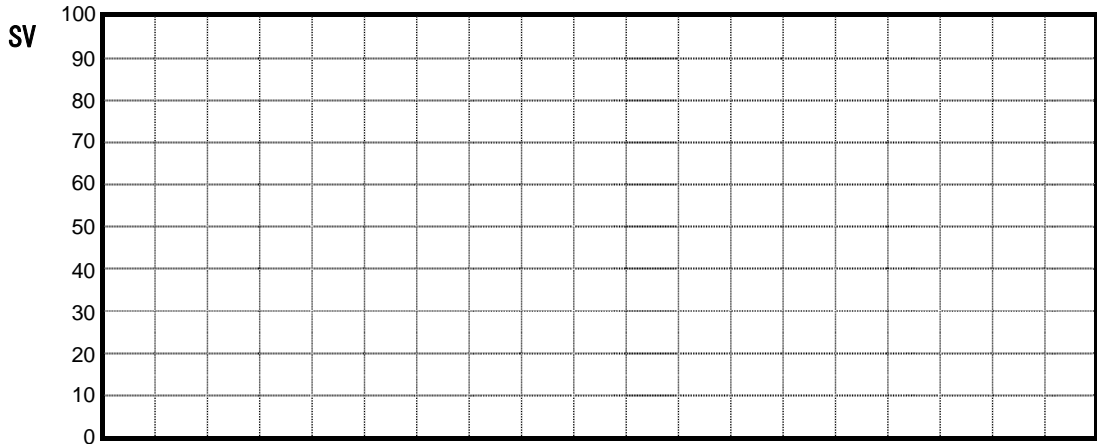

Step No.	00	01	02	03	04	05	06	07	08	09	10	11	12	13	14	15	16	17	18	19
----------	----	----	----	----	----	----	----	----	----	----	----	----	----	----	----	----	----	----	----	----

Selection of start method		PV																				
		SV																				
Program pattern	SV																					
	TIME																					
	Step repeat																					
Sequence	PID No.																					
	Alarm No.																					
	Output limit No.																					
	Output variation limit No.																					
	Sensor compensation No.																					
	Time signal	TS1																				
		TS2																				
		TS3																				
		TS4																				
		TS5																				
Actual temperature No.																						
Wait time alarm No.																						

MODE3

PID							
No.	P(%)	I(%)	D(%)	No.	P(%)	I(%)	D(%)
Default	5.0	60	30	Default	5.0	60	30
1				9-1			
2				9-2			
3				9-3			
4				9-4			
5				9-5			
6				9-6			
7				9-7			
8				9-8			
Setting range	000.0 to 999.9	0000 to 9999	0000 to 9999	Setting range	000.0 to 999.9	0000 to 9999	0000 to 9999

Alarm				
No.	AL1	AL2	AL3	AL4
Default	3000.0	-1999.9	3000.0	-1999.9
1				
2				
3				
4				
5				
6				
7				
8				
Setting range	-1999.9 to 3000.0	-1999.9 to 3000.0	-1999.9 to 3000.0	-1999.9 to 3000.0

MODE4

Output limit		
No.	L (%)	H (%)
Default	0.0	100.0
1		
2		
3		
4		
5		
6		
7		
8		
Setting range	-5.0 to 100.0	0.0 to 105.0

Output variation		
No.	UP (%)	DOWN (%)
Default	100.0	-100.0
9-1		
9-2		
9-3		
9-4		
9-5		
9-6		
9-7		
9-8		
Setting range	000.1 to 100.0	-100.0 to -000.1

MODE5

Sensor compensation	
No.	Compensation value
Default	0.0
1	
2	
3	
4	
5	
6	
7	
8	
Setting range	-199.99 to 2000.00

MODE6

Time signal		
No.	ON	OFF
Default	000:00	001:00
1		
2		
3		
4		
5		
6		
7		
8		
Setting range	000:00 to 999:59	000:00 to 999:59

Actual temperature compensation	
No.	Deviation value
Default	2000.0
1	
2	
3	
4	
5	
6	
7	
8	
Setting range	0000.1 to 20000.0

Wait time alarm	
No.	Wait time
Default	001:00
1	
2	
3	
4	
5	
6	
7	
8	
Setting range	000:00 to 999:59

### [Parameters related to Auto Tuning]

Mode No.	Setting Item		Default value (During default settings)	Customer setting value (Execution No. )								Setting Range
				1	2	3	4	5	6	7	8	
3	SV for AT2	Execution	ON only for No. 1									ON, OFF
		SV	Automatic deployment									-19999 to 30000
	SV for AT3	Execution	ON only for No. 1									ON, OFF
		SV	Automatic deployment									Auto PID switch between SV

### [Parameters related to Automatic PID switching method]

Mode No.	Setting Item		Default value (During default settings)	Customer setting value (Execution No. )								Setting range
				9-1	9-2	9-3	9-4	9-5	9-6	9-7	9-8	
3	PID	P	005.0%									000.0 to 999.9
		I	0060S									0000 to 9999
		D	0030S									0000 to 9999
	Automatic PID switching method SV interval		Automatic deployment									Measurement scope, linear scale

# 18. Parameter directory list

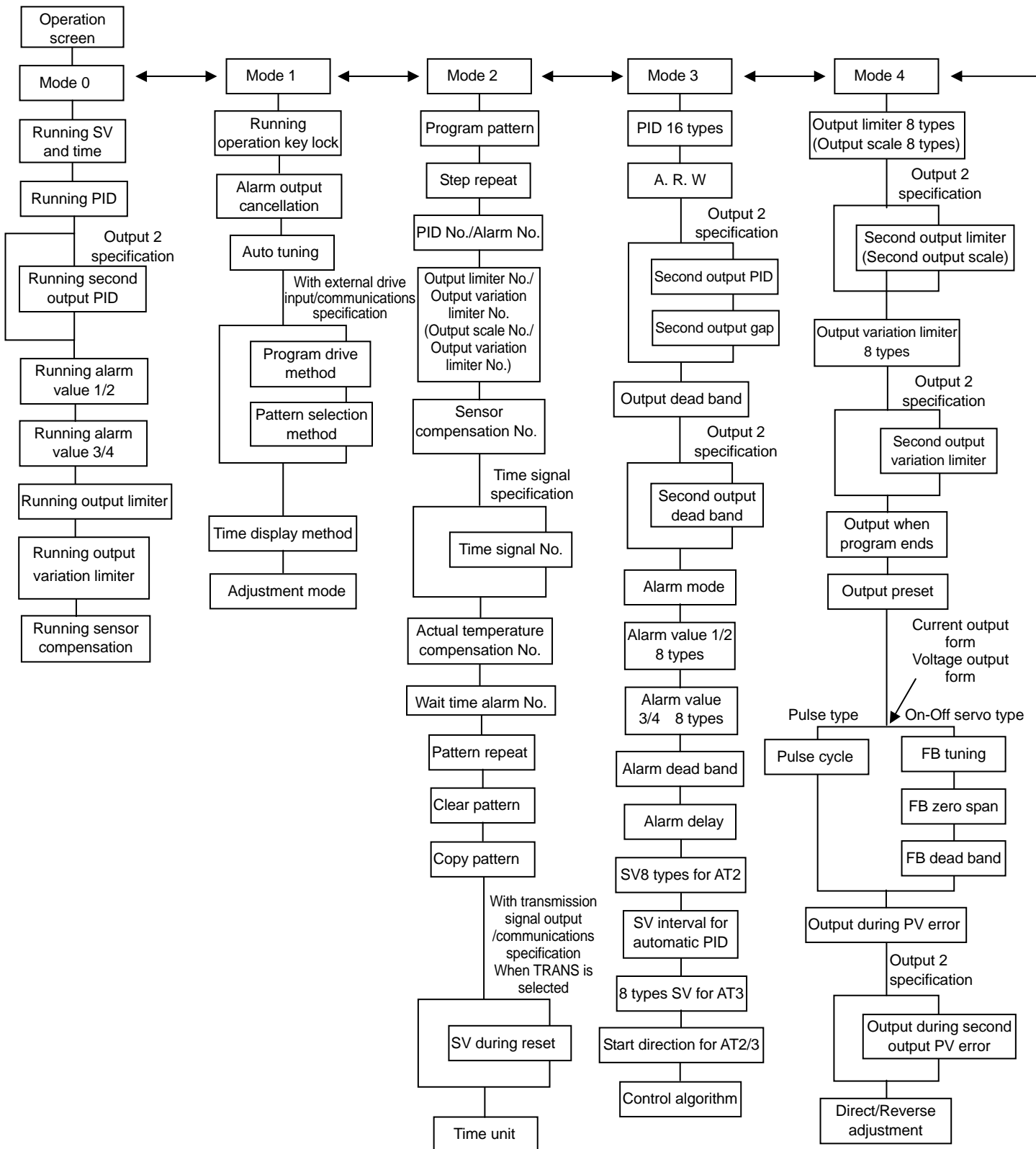

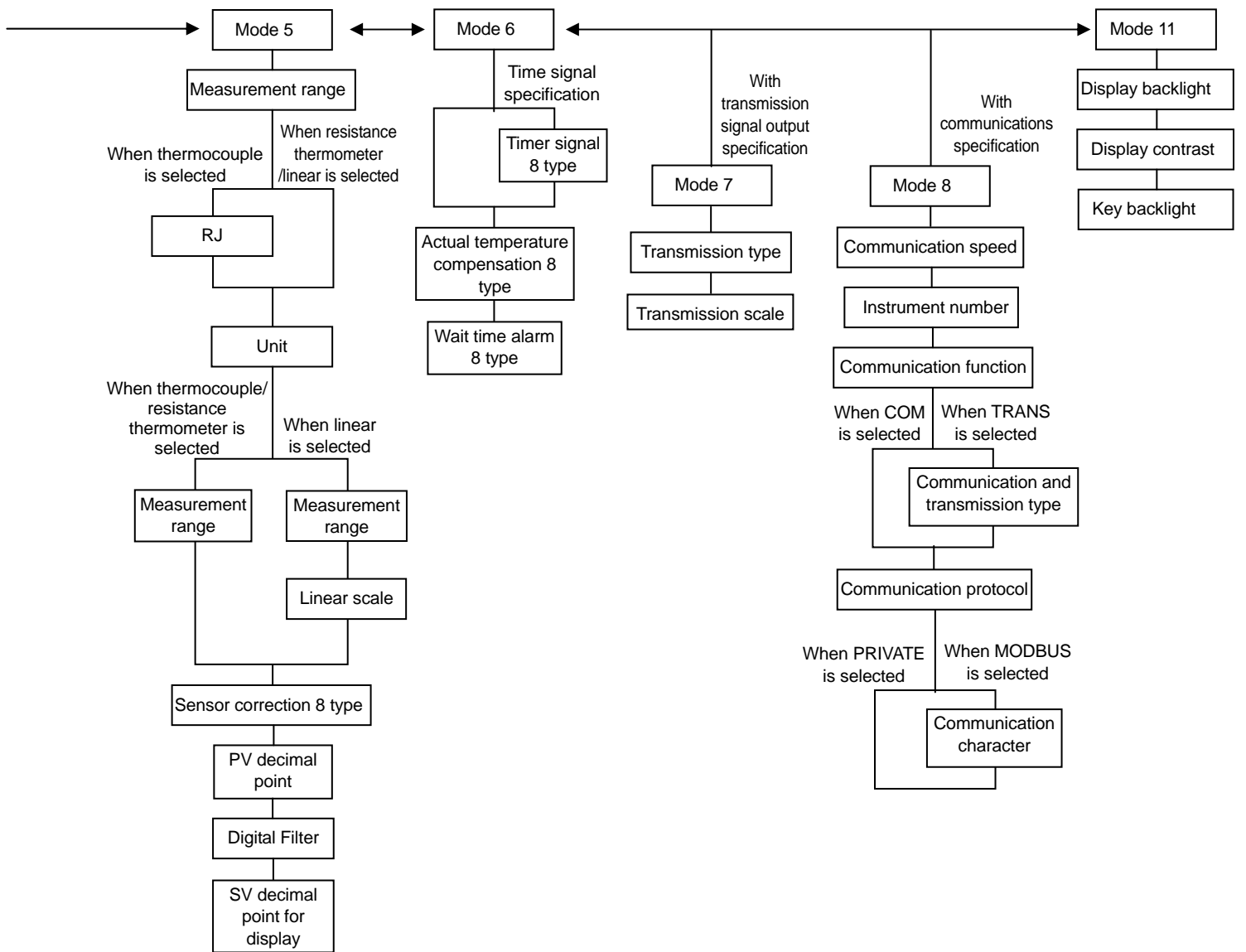

---

---

## 19. Engineering unit sticker

---

---

The controller is supplied with sticker for engineering unit. Fix it in the appropriate position as shown in the upper display as per your convenience.

Then after some time after fixing this sticker, there may be peeling-off of the sticker or degradation of character printing due to adhesion degradation.



### Precaution

Unincorporated measurement units that are not decided by the measurement laws are included in this unit seal.





# CHINO

---

## CHINO CORPORATION

32-8,KUMANO-CHO,ITABASHI-KU,TOKYO 173-8632

Telephone:81-3-3956-2171

Facsimile:81-3-3956-0915

E-mail: [inter@chino.co.jp](mailto:inter@chino.co.jp)

---

